

Acyclic Sets of Linear Orders via the Bruhat Orders[★]

Ádám Galambos¹, Victor Reiner²

¹ Department of Managerial Economics and Decision Sciences, Kellogg School of Management, Northwestern University, e-mail: a-galambos@kellogg.northwestern.edu

² Department of Mathematics, University of Minnesota, e-mail: reiner@math.umn.edu

The date of receipt and acceptance will be inserted by the editor

Abstract We describe Abello's acyclic sets of linear orders [1] as the permutations visited by commuting equivalence classes of maximal reduced decompositions. This allows us to strengthen Abello's structural result: we show that acyclic sets arising from this construction are distributive sublattices of the weak Bruhat order. This, in turn, shows that Abello's acyclic sets are, in fact, the same as Chameni-Nembua's *distributive covering sublattices (S.T.D.C's)*. Fishburn's *alternating scheme* is shown to be a special case of the Abello/Chameni-Nembua acyclic sets. Any acyclic set that arises in this way can be represented by an arrangement of pseudolines, and we use this representation to derive a simple closed form for the cardinality of the alternating scheme. The higher Bruhat orders prove to be a natural mathematical framework for this approach to the acyclic sets problem.

1 Introduction

Majority voting is one of the most commonly accepted and widely practiced methods for aggregating preferences. First observed by the Marquis de Condorcet [6], today it is well-known that social preferences determined by majority voting on every pair of alternatives may be intransitive. On the other hand, if voters' preferences are restricted to lie within certain domains, the problem of intransitivity can be avoided. Social choice theorists have found several such domain restrictions [22, 20], and this has led to the question: Given n alternatives, what is the cardinality of the largest domain of linear orders that still guarantees transitive social preferences

[★] We would like to thank the Editor, Professor Bernard Monjardet, and two anonymous referees for their comments and additional references.

under pairwise majority voting?¹ Such a domain is called an *acyclic set of linear orders*.²

The question of finding maximum cardinality acyclic sets has proven to be one of the most difficult combinatorial questions in social choice theory [13]. While several upper and lower bounds have been found, and others conjectured [1, 8, 12, 19, 13], the only successful attempts to study the *structure* of “large” acyclic sets are Abello’s [1] and Chameni-Nembua’s [5]. Abello showed that a maximal chain in the *weak Bruhat order* forms an acyclic set.³ Moreover, any maximal acyclic set containing a maximal chain is an upper semimodular sublattice of the weak Bruhat order [1, Theorem 3.3]. Chameni-Nembua showed that *covering distributive sublattices* of the weak Bruhat order (abbreviated *S.T.D.C.* for *sous-treillis distributif couvrant*) always form acyclic sets. These S.T.D.C. lattices can always be extended (while remaining S.T.D.C.’s) to contain the identity permutation and its reverse [5, Theorems 3.6 and 3.7]. We show that such extended lattices are exactly the acyclic sets considered by Abello. Part of the point of our work is to explain these Chameni-Nembua/Abello distributive lattices as the lattices of order ideals of particularly simple posets. We also show that Fishburn’s *alternating scheme* [12, 13] is a special case of the Chameni-Nembua/Abello lattices. Our approach is based on results on the higher Bruhat orders [23, 11]. Placing Fishburn’s alternating scheme in this formal framework allows us to derive an explicit formula for its cardinality.

In section 2 we define the combinatorial objects we will use, and discuss the relationships among them. In section 3 we describe explicitly the maximal acyclic sets that contain a maximal chain in the weak Bruhat order, and show how the alternating scheme fits in that framework. We derive the formula enumerating the alternating scheme in section 3.1.

2 Definitions

Let \mathcal{R} be the set of all total, transitive, reflexive and antisymmetric binary relations (i.e. linear orders) on a finite set A of social alternatives. The finite set of agents will be denoted by I , and their preferences $(R_i)_{i \in I}$ are from \mathcal{R} . Under majority voting, social preferences R^M are defined by: for all $a, b \in A$

$$aR^M b \iff |\{i \in I : aR_i b\}| \geq |\{i \in I : bR_i a\}|. \quad (1)$$

For simplicity, we identify the n -set A with the set $[n] := \{1, 2, \dots, n\}$ under an arbitrary, fixed ordering of A , and we represent individual preferences as

¹ We assume throughout that the number of voters is at least 3. This question can be posed without reference to the number of voters because if a preference profile results in intransitive social preferences under majority voting, then it contains 3 preferences that would, by themselves, result in such intransitivity [20].

² Henceforth *acyclic sets*.

³ An early study by Blin describes Abello’s “pseudo-chains” as “multidimensionally consistent” sets [4].

permutations of $[n]$. A permutation $\pi : [n] \rightarrow [n]$ will be identified with the linear order

$$\pi^{-1}(1) > \pi^{-1}(2) > \cdots > \pi^{-1}(n), \quad (2)$$

and will be written as $\pi^{-1}(1) \pi^{-1}(2) \cdots \pi^{-1}(n)$. The set of permutations is denoted by S_n .

Definition 1 *A set $T \subseteq S_n$ is acyclic if for all $i, j, k \in [n]$, at most two of the orders ijk, jki, kij appear as a restriction to $\{i, j, k\}$ of some order in T .*

Ward [22] introduced this condition as *latin squarelessness*,⁴ and showed that with an odd number of voters it guarantees transitive majority. Sen [20] introduced this condition for the setting where indifference in individual preferences is allowed, and called it the “assumption of value-restricted preferences.” He showed that in that setting it guarantees transitive majority. While a profile of preferences that is *not* acyclic may produce a transitive social preference under majority voting, acyclicity is clearly necessary in the following sense: *if a domain of preferences always produces a transitive majority regardless of how many agents have each particular preference relation, then this domain must be acyclic.*⁵

Abello [1] and Chameni-Nembua [5] used the structure imposed on the set S_n of linear orders by the weak Bruhat order to construct acyclic sets. Since then significant work has been done on the *higher Bruhat orders* [17, 18, 23, 11]. Some of these results are central to our approach, so we present them as we give the following definitions.

For any permutation $\pi \in S_n$, let

$$\text{inv}(\pi) := \{\{i, j\} : i < j \text{ and } \pi(i) > \pi(j)\} \quad (3)$$

denote the *inversion set* of π . For example, $\text{inv}(2143) = \{\{1, 2\}, \{3, 4\}\}$. Let $B(n, 1) := \{\text{inv}(\pi) : \pi \in S_n\}$.

Definition 2 *The weak Bruhat order $\mathbb{B}(n, 1)$ is the partial order on $B(n, 1)$ defined by the transitive closure of single step set inclusion. That is, we decree for two permutations σ and π that $\text{inv}(\pi)$ is less than $\text{inv}(\sigma)$ when $\text{inv}(\pi) \subseteq \text{inv}(\sigma)$ with $|\text{inv}(\pi)| + 1 = |\text{inv}(\sigma)|$, and then we take the transitive closure of this relation.*

The weak Bruhat order is a lattice, and it is the same as $B_{\subseteq}(n, 1)$, the set $B(n, 1)$ partially ordered by set inclusion⁶ [16].

⁴ Ward comments on the term: “awkward, but there is a suggestive rhythmic harmony with its predecessor, single peakedness.” [22]

⁵ Notice that acyclicity is a property of a *set* of preferences, not of a *profile* of preferences. It is for this reason that we do not discuss restrictions on the parity of the number of agents, although, for any particular preference profile, it is important.

⁶ The lattice property has been generalized to the weak order on finite Coxeter groups [2, Section 3.2].

Since every permutation of $[n]$ can be uniquely identified by its inversion set, the weak Bruhat order can also be viewed as a partial order on permutations. For example, part b) of Figure 1 shows the weak Bruhat order $\mathbb{B}(3, 1)$, while part a) shows it as a partial order on S_3 .

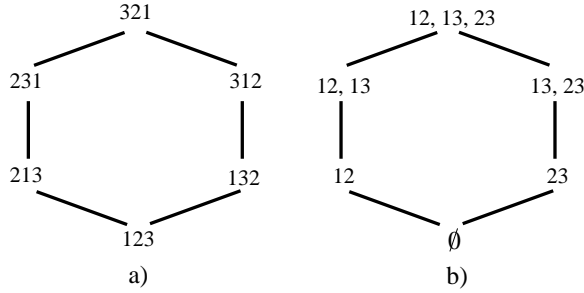

Fig. 1 The weak Bruhat order $\mathbb{B}(3, 1)$

A *maximal chain* in $\mathbb{B}(n, 1)$ is a sequence of permutations $(\pi_1, \pi_2, \dots, \pi_l)$ such that π_{i+1} covers π_i for $i = 1, \dots, l - 1$, and π_1 is the identity while π_l is its reverse. These conditions force that the length l of this sequence will be $\binom{n}{2}$. A maximal chain can be identified by the sequence of transpositions that generates it. For example, we could identify the maximal chain

$$1234, 2134, 2314, 2341, 3241, 3421, 4321 \quad (4)$$

by saying: transpose the first and the second element, then the second and the third, etc. Since we always transpose adjacent elements, naming just the position of the left element to be transposed suffices. Denoting the transpositions of the i th and the $i + 1$ st element by s_i , we could describe the above sequence as

$$1234 \xrightarrow{s_1} 2134 \xrightarrow{s_2} 2314 \xrightarrow{s_3} 2341 \xrightarrow{s_1} 3241 \xrightarrow{s_2} 3421 \xrightarrow{s_1} 4321. \quad (5)$$

In fact, we may even omit the permutations — we could always recover them from the sequence of transpositions: $s_1 s_2 s_3 s_1 s_2 s_1$. We assume, implicitly, that the sequence of permutations always starts with the identity. Such a sequence of increasing adjacent transpositions s_i , resulting in the reverse of the identity, is called a *maximal reduced decomposition* [3, Section 6.4].⁷ The *permutations visited by a maximal reduced decomposition* are the permutations in the maximal chain it corresponds to in the weak Bruhat

⁷ *Maximal* because it starts with the identity and ends with its reverse, and *reduced* because it has minimum length (namely $\binom{n}{2}$) among all the ones that start with the identity and end with its reverse. The latter requirement is equivalent to allowing only increasing transpositions: $\dots ij \dots \rightarrow \dots ji \dots$ with $i < j$.

order. For example, the permutations visited by $s_1 s_2 s_3 s_1 s_2 s_1$ above are

$$\begin{aligned}
 id &= 1234 & (6) \\
 s_1 &= 2134 \\
 s_1 s_2 &= 2314 \\
 s_1 s_2 s_3 &= 2341 \\
 s_1 s_2 s_3 s_1 &= 3241 \\
 s_1 s_2 s_3 s_1 s_2 &= 3421 \\
 s_1 s_2 s_3 s_1 s_2 s_1 &= 4321.
 \end{aligned}$$

A maximal reduced decomposition can also be viewed as a permutation of $\binom{[n]}{2}$, the 2-subsets of $[n]$. Since it starts with the identity and ends with its reverse, every pair must be transposed, and since it is *reduced*, every pair must be transposed exactly once. The sequence of these transpositions gives us a permutation of (unordered) pairs. In fact, a structure that generalizes the weak Bruhat order can be imposed on the set of all such permutations of pairs. More precisely, the higher Bruhat order $\mathbb{B}(n, 2)$ is defined⁸ on the *inversion sets* of certain permutations of $\binom{[n]}{2}$.

Definition 3 [23] *A permutation π of $\binom{[n]}{2}$ is admissible if the 2-subsets of any 3-subset of $[n]$ appear either in lexicographic or in reversed lexicographic order in it. That is, for any $1 \leq i < j < k \leq n$, the sets $\{i, j\}, \{i, k\}, \{j, k\}$ appear in π either in the order $\{i, j\}, \{i, k\}, \{j, k\}$ or in the order $\{j, k\}, \{i, k\}, \{i, j\}$. The inversion set $\text{inv}(\pi) \subseteq \binom{[n]}{3}$ of an admissible permutation π is the set of 3-subsets of $[n]$ whose 2-subsets appear in reversed lexicographic order in π .*

For example, $\text{inv}(\{1, 2\}\{3, 4\}\{1, 4\}\{2, 4\}\{1, 3\}\{2, 3\}) = \{\{1, 3, 4\}, \{2, 3, 4\}\}$.

Definition 4 [23] *Let*

$$B(n, 2) := \left\{ \text{inv}(\pi) : \pi \text{ is an admissible permutation of } \binom{[n]}{2} \right\}. \quad (7)$$

*The higher Bruhat order $\mathbb{B}(n, 2)$ is the partial order on $B(n, 2)$ defined by the transitive closure of single step set inclusion.*⁹

⁸ The higher Bruhat orders $\mathbb{B}(n, k)$ are defined analogously on the set of permutations of k -subsets of $[n]$ (see [23]). Since we use only $\mathbb{B}(n, 2)$, we specialize the definitions to $k = 2$.

⁹ The higher Bruhat order $\mathbb{B}(n, 2)$ is the same as $B_{\subseteq}(n, 2)$, the set $B(n, 2)$ partially ordered by set inclusion [9]. Note, however, that the analogous statement does not hold for all $\mathbb{B}(n, k)$ [23]. Higher Bruhat orders have been shown to be closely related to other combinatorial structures, such as hyperplane arrangements, tilings, and wiring diagrams.

Notice that the order is defined on *inversion sets*, not on the permutations themselves. While the inversion set (a set of 2-subsets of $[n]$) of a permutation of $[n]$ determines the permutation uniquely, the inversion set (a set of 3-subsets of $[n]$) of a permutation of $\binom{[n]}{2}$ determines an *equivalence class* of permutations, as illustrated below.

A maximal chain in the weak Bruhat order, when viewed as a permutation of 2-subsets, is admissible [23, Lemma 2.4]. Moreover, every admissible permutation of $\binom{[n]}{2}$ can be naturally identified with a maximal chain in the weak Bruhat order [23, Theorem 4.1(A)][18]. Since maximal chains in $\mathbb{B}(n, 1)$ can be thought of as maximal reduced decompositions, we have that admissible permutations of $\binom{[n]}{2}$, maximal chains in $\mathbb{B}(n, 1)$ and maximal reduced decompositions are essentially equivalent objects. How can we identify admissible permutations (or maximal chains in $\mathbb{B}(n, 1)$, or maximal reduced decompositions) that have the same inversion sets and thus are mapped to the same element of $\mathbb{B}(n, 2)$? Lemma 2.2 in [23] answers this question: two admissible permutations of $\binom{[n]}{2}$ have the same inversion set if, and only if, they are *equivalent* in the equivalence relation induced by the notion of *elementary equivalence*:

Definition 5 [23, Def. 2.1][18, Def. 2.2] *Two admissible permutations of $\binom{[n]}{2}$ are elementarily equivalent if they differ by an interchange of two disjoint neighbors.*¹⁰

To summarize, we illustrate the correspondences among permutations of 2-subsets, maximal reduced decompositions, and maximal chains in the weak Bruhat order.¹¹ The weak Bruhat order $\mathbb{B}(4, 1)$ is shown in Figure 2. Four maximal chains with their corresponding permutations of $\binom{[n]}{2}$ and maximal reduced decompositions are shown in Figure 3, which the reader may find a useful reference in later discussions as well. These four permutations of $\binom{[n]}{2}$ are, in fact, equivalent — they all have $\{\{1, 3, 4\}, \{2, 3, 4\}\}$ as their inversion set. The union of the four maximal chains is the subposet of $\mathbb{B}(4, 1)$ highlighted in Figure 2. The permutations visited by the four maximal reduced decompositions are the permutations in this highlighted subposet. When a set of maximal reduced decompositions correspond to an equivalence class of permutations of $\binom{[n]}{2}$, we will call them an *equivalence class of maximal reduced decompositions*. Theorem 1 below states that the permutations visited by an equivalence class of maximal reduced decompositions form an acyclic set.

Since equivalence classes of maximal reduced decompositions turn out to be the central objects in our analysis, we would like to have a concise representation of them. In fact, an equivalence class of maximal reduced

¹⁰ The Lemma and the Definition are originally formulated for permutations of $\binom{[n]}{k}$, $k \geq 1$, though here we consider only the case $k = 2$. In general, the neighbors to be interchanged must have at most $k - 2$ common elements.

¹¹ See also [10] on the correspondences among these objects.

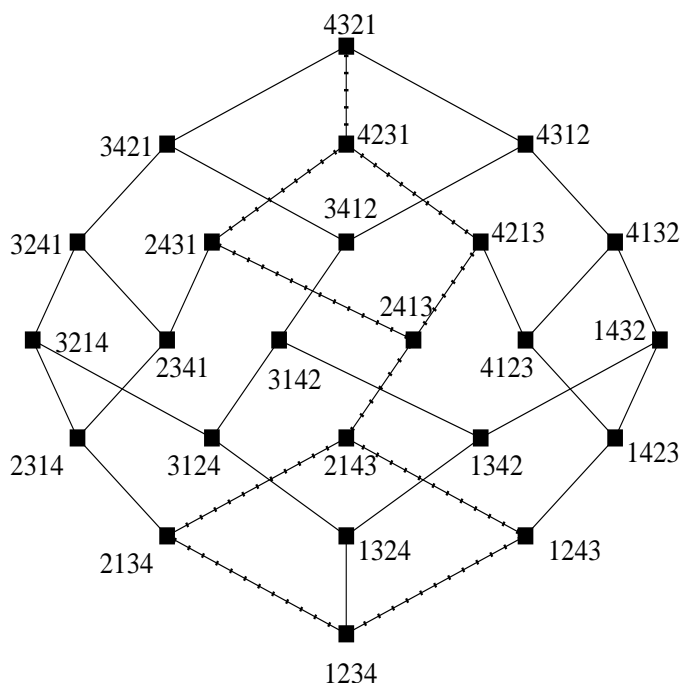

Fig. 2 The weak Bruhat order $\mathbb{B}(4, 1)$

decompositions can be represented in a particularly useful way as an *arrangement of pseudolines*.

2.1 Arrangements of pseudolines

We illustrate how one can represent an equivalence class of maximal reduced decompositions as an arrangement of pseudolines¹² by demonstrating it on the example used in (6): $s_1 s_2 s_3 s_1 s_2 s_1$. We associate a (*pseudo*-)line with each of the numbers 1, 2, 3 and 4, and represent the starting permutation, 1234, by placing them in that order. The numbers 4, 3, 2, 1 on the right indicate that the pseudolines will end up in that order after we carry out all the transpositions. The first transposition, s_1 , corresponds to crossing the first and second pseudolines (see Figure 5). The next transposition is s_2 , so we cross the second and the third pseudolines.¹³ Continuing this way, we

¹² The arrangements we consider are, in fact, *simple numbered arrangements of pseudolines*. For more on arrangements and their relation to maximal chains see [3, Section 6.4] and [15], and for the correspondence between arrangements and elements of $\mathbb{B}(n, 2)$ see [9, p. 122].

¹³ Notice that we did *not* cross the pseudoline that is labelled 2, but, rather, the second pseudoline from the top of the diagram, labelled 1 (with the third). See Figure 5.

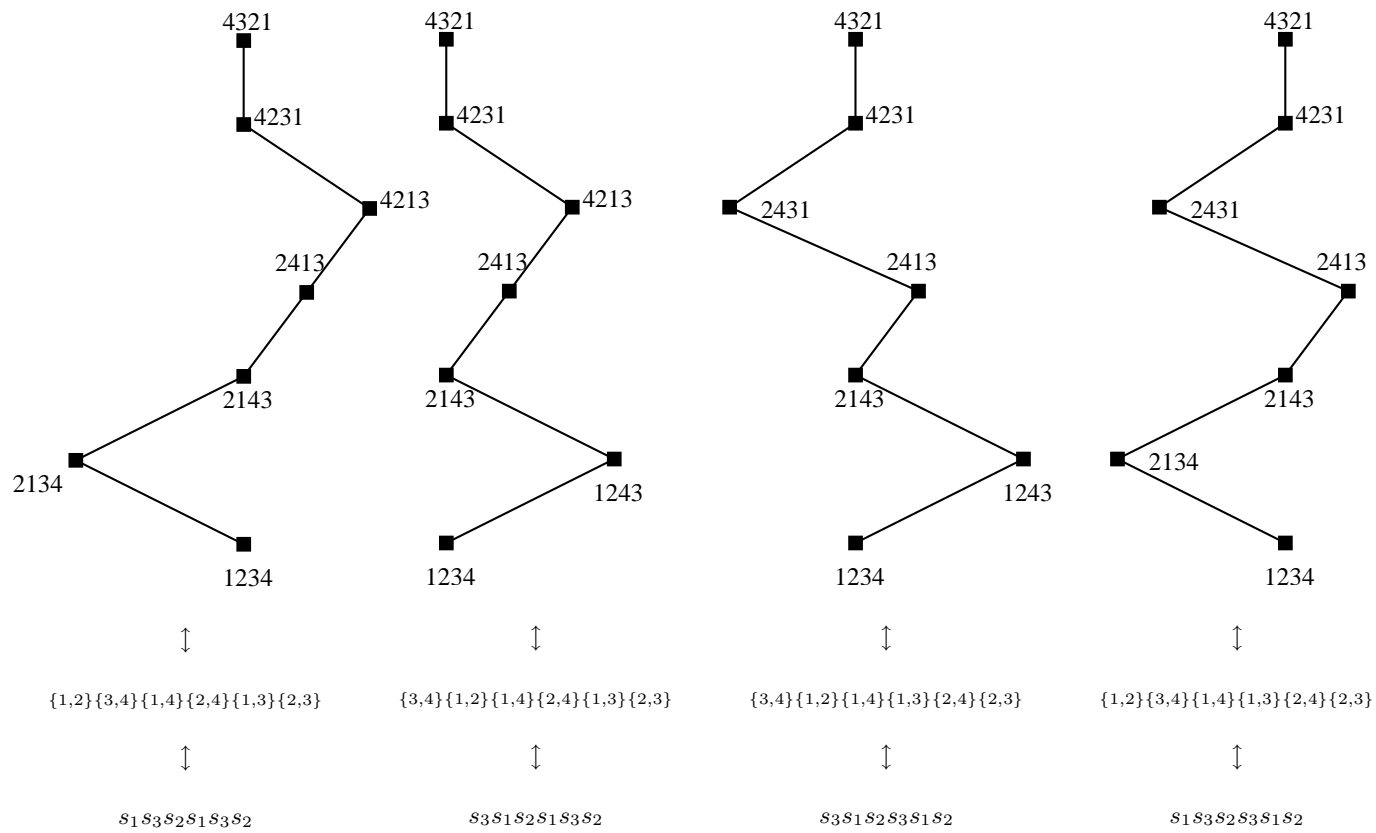

Fig. 3 The correspondences among permutations of $\binom{[n]}{2}$, maximal chains, and maximal reduced decompositions

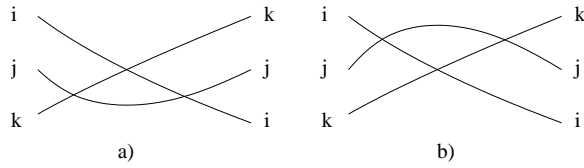

Fig. 4 The set $\{i, j, k\}$ is an inversion in a), but not in b)

cross the third and fourth pseudolines to represent s_3 . In general, for s_i we cross the i th and $i + 1$ st pseudoline from the top. After we carry out all the transpositions in the maximal reduced decomposition $s_1 s_2 s_3 s_1 s_2 s_1$, we get the arrangement of pseudolines shown in Figure 5.

It is easy to see that, given a maximal reduced decomposition, one can construct from it an arrangement of pseudolines the way we did above. But will distinct maximal reduced decompositions result in distinct arrangements? The example above reveals that the answer must be “no.” The maximal reduced decomposition $s_1 s_2 s_1 s_3 s_2 s_1$ would result in exactly the same arrangement — in other words, switching the adjacent s_1 and s_3 does not change the arrangement. In general, the maximal reduced decompositions that correspond to the same arrangements of pseudolines are equivalent [14]. Thus we can represent an equivalence class of maximal reduced decompositions as an arrangement of pseudolines. It will be significant in section 3.1 that the inversion set $I \in \mathbb{B}(n, 2)$ corresponding to the equivalence class can be identified in the arrangement as follows. The restriction of the arrangement to any triple $i < j < k$ will either look like an upward pointing triangle or like a downward pointing triangle (Figure 4). In the first case $\{i, j, k\}$ is an inversion, while in the second case it is not.

Though it is implicit in the above construction, we emphasize that the permutations visited by an equivalence class of maximal reduced decompositions can be recovered from its corresponding arrangement. Each such permutation corresponds to an additional pseudoline added to the arrangement, i.e. a new pseudoline that crosses every other pseudoline exactly once. The permutation corresponding to such a pseudoline is obtained by carrying out all the transpositions that correspond to the vertices to the left of the new pseudoline. For example, the pseudoline in Figure 6 corresponds to $s_1 s_2 s_1$, i.e. to 3214. Equivalently we could describe the permutation as the order in which the new pseudoline crosses the four original pseudolines: first it crosses pseudoline 3, then pseudoline 2, pseudoline 1 and pseudoline 4. Another way to describe this idea is through defining a natural partial order on the crossings of the arrangement of pseudolines.

Definition 6 Let \mathcal{V}_n be the set of crossings of an arrangement of pseudolines \mathcal{A} on n strings. The natural partial order $P_{\mathcal{A}}$ on the crossings \mathcal{V}_n is

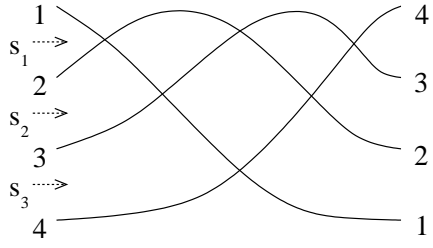

Fig. 5 The arrangement of pseudolines corresponding to $s_1 s_2 s_3 s_1 s_2 s_1$

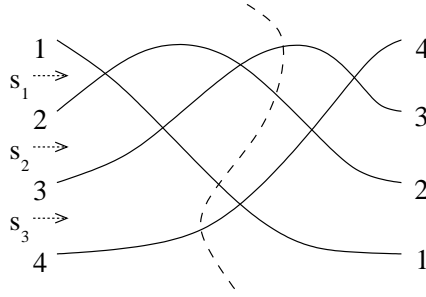

Fig. 6 The permutation corresponding to this new pseudoline is 3214

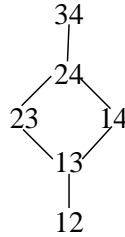
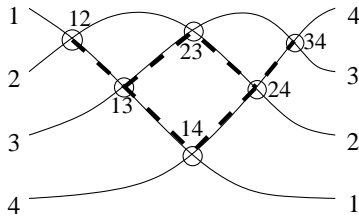

Fig. 7 The natural partial order on the crossings of an arrangement

the transitive closure of the relation $P_{\mathcal{A}}^0$ defined by

$$ij P_{\mathcal{A}}^0 kl \iff \{i, j\} \cap \{k, l\} \neq \emptyset \tag{8}$$

and ij is to the left of kl on the pseudoline connecting them.

For example, the arrangement in Figure 5 has $\mathcal{V} = \{12, 13, 14, 23, 24, 34\}$ as its crossing set, and its natural partial order is the transitive closure of:

$$\begin{aligned} &12 P_{\mathcal{W}}^0 13 && (9) \\ &13 P_{\mathcal{W}}^0 14 \\ &12 P_{\mathcal{W}}^0 23 \\ &23 P_{\mathcal{W}}^0 24 \\ &13 P_{\mathcal{W}}^0 23 \\ &23 P_{\mathcal{W}}^0 34 \\ &14 P_{\mathcal{W}}^0 24 \\ &24 P_{\mathcal{W}}^0 34. \end{aligned}$$

Figure 7 illustrates how the natural partial order is constructed. Drawing a new pseudoline, as above, now determines an order ideal in the natural partial order. For example, the new pseudoline drawn in Figure 6 corresponds to the ideal generated by the crossing 23. Thus, in general, the lattice of ideals of the natural partial order can be thought of as a partial order on

the permutations visited by the equivalence class of maximal reduced decompositions corresponding to the arrangement. Moreover, as we show in Theorem 2, this lattice is a sublattice of the weak Bruhat order.

3 “Large” acyclic sets

Abello [1] and Fishburn [12, 13] constructed “large” acyclic sets using seemingly different approaches. We will show that both constructions are based on the same basic idea, namely that permutations visited by an equivalence class of maximal reduced decompositions form an acyclic set (Theorem 1 below). Moreover, we show that the acyclic sets implicitly defined by Abello are exactly the S.T.D.C’s described by Chameni-Nembua (Theorem 2 below). In Theorem 3 we show that Fishburn’s alternating scheme is the set of permutations visited by the equivalence class of a particular maximal reduced decomposition, and we conjecture that it is the largest acyclic set obtainable via this construction. Before we state our results, we describe the alternating scheme and a useful generalization.

Fishburn [12] noted that a set of permutations is acyclic if, and only if, every triple $1 \leq i < j < k \leq n$ satisfies a *never constraint* of the form “ a is never b th in the restriction to $\{i, j, k\}$,” where $a \in \{i, j, k\}$ and $b \in \{1, 2, 3\}$.¹⁴ A never constraint is written as

$$aN_bijk. \quad (10)$$

The alternating scheme is a set of such never constraints:

Definition 7 *The alternating scheme is the following set of never constraints:*¹⁵

$$\begin{array}{ll} \text{for all } 1 \leq i < j < k \leq n, & jN_3ijk & \text{if } j \text{ is even} \\ & jN_1ijk & \text{if } j \text{ is odd.} \end{array} \quad (11)$$

The following generalization of the alternating scheme will be useful.

Definition 8 *Let $U \subseteq \binom{[n]}{3}$. The set of U -constraints is the following set of never constraints:*

$$\begin{array}{ll} \text{for all } 1 \leq i < j < k \leq n, & jN_3ijk & \text{if } \{i, j, k\} \notin U \\ & jN_1ijk & \text{if } \{i, j, k\} \in U. \end{array} \quad (12)$$

In particular, the alternating scheme is the set of U_A -constraints, where

$$U_A = \{\{i, j, k\} | 1 \leq i < j < k \leq n \text{ and } j \text{ is odd}\}. \quad (13)$$

¹⁴ It is easy to see that this is equivalent to acyclicity (Definition 1).

¹⁵ Fishburn defines two “dually equivalent” [12] alternating schemes. For simplicity, we introduce only one of these.

Every acyclic set described in this paper will satisfy a set of U -constraints for some $U \in \mathbb{B}(n, 2)$. The following two theorems restate Abello's Theorem 3.2 [1] (see also his Concluding Remarks), with a slight extension. Theorem 1 is also easily deduced from Chameni-Nembua's Theorem 3.6 [5]. For our purposes, it is useful to state and to prove these results using the language of maximal reduced decompositions.

Theorem 1 *The permutations visited by an equivalence class of maximal reduced decomposition form an acyclic set.*

Proof As discussed before and after Definition 5, equivalent maximal reduced decompositions correspond¹⁶ to permutations of $\binom{[n]}{2}$ with the same inversion set. That is, all the maximal reduced decompositions in the equivalence class can be written as permutations of $\binom{[n]}{2}$ with the same inversion set, say $I \subseteq \binom{[n]}{3}$. We will show that the permutations visited by this equivalence class of maximal reduced decompositions satisfy the set of I -constraints. Suppose $\{i, j, k\} \in I$, with $1 \leq i < j < k \leq n$. Since $\{i, j, k\}$ is an inversion, in any maximal reduced decomposition in the equivalence class it must be that j and k are transposed before i and j are. That is, any permutation visited by the equivalence class satisfies the never constraint jN_1ijk . A similar argument shows that for any $\{i, j, k\} \notin I$, with $1 \leq i < j < k \leq n$, the never constraint jN_3ijk is satisfied by all permutations visited by the equivalence class. Thus these permutations satisfy a set of never constraints and so they form an acyclic set. ■

Theorem 1 provides an explicit construction of large acyclic sets — but are these the *maximal* acyclic sets that contain a maximal chain in the weak Bruhat order? Theorem 2 below shows that they are. It also slightly strengthens Abello's result: a maximal acyclic set that contains a maximal chain in the weak Bruhat order forms not only an upper semimodular sublattice of the weak Bruhat order, but, in fact, a *distributive* sublattice. This proves that Abello's acyclic sets are the same as Chameni-Nembua's S.T.D.C's.

Theorem 2 *Let C be a maximal chain in the weak Bruhat order $\mathbb{B}(n, 1)$ (considered as a partial order on permutations). The largest acyclic set of permutations containing C is the set of permutations visited by the equivalence class of the maximal reduced decomposition corresponding to C . This acyclic set forms a distributive sublattice of $\mathbb{B}(n, 1)$.*

Proof Let $I \in \mathbb{B}(n, 2)$ be the inversion set corresponding to C . We have shown in Theorem 1 that the set of permutations visited by the equivalence class of the maximal reduced decomposition corresponding to C form an acyclic set. In particular, all these permutations satisfy the set of I -constraints. The following Claim shows that no other permutation satisfies all the I -constraints.

¹⁶ see Figure 3

Claim Let $U \subseteq \binom{[n]}{3}$ be an element of the higher Bruhat order $\mathbb{B}(n, 2)$ (i.e. U is an inversion set). If a permutation π of $[n]$ satisfies the set of U -constraints, then it is one of the permutations visited by the commuting equivalence class of maximal reduced decompositions that corresponds to U . That is, it is a permutation of some maximal reduced decomposition that corresponds to an admissible permutation (of $\binom{[n]}{2}$) with inversion set U .

Proof of Claim By Lemma 2.2 of [23] we only need to show that the inversion set $I \subseteq \binom{[n]}{2}$ of π constitutes an ideal in the poset Q that is the intersection of all admissible orders with inversion set U . It is easy to see that Q is the transitive closure of the following relations: for all $1 \leq i < j < k \leq n$,

$$\{i, j\}Q\{i, k\} \text{ and } \{i, k\}Q\{j, k\} \text{ if } \{i, j, k\} \notin U \quad (14)$$

$$\{j, k\}Q\{i, k\} \text{ and } \{i, k\}Q\{i, j\} \text{ if } \{i, j, k\} \in U. \quad (15)$$

By Lemma 2.4 in [23], for all $1 \leq i < j < k \leq n$, the inversion set of any permutation can include only an initial or a final segment of $\{i, j\}, \{i, k\}, \{j, k\}$. Since π satisfies the set of U -constraints, its inversion set must include an initial segment of $\{i, j\}, \{i, k\}, \{j, k\}$ if $\{i, j, k\} \notin U$, and a final segment of $\{i, j\}, \{i, k\}, \{j, k\}$ if $\{i, j, k\} \in U$. Since Q is defined by (14) and (15), this proves that the inversion set of π is indeed an ideal in Q .

To show the second claim in the Theorem, consider the arrangement of pseudolines representing the equivalence class of maximal reduced decompositions. The permutations visited by the equivalence class correspond to ideals of the natural partial order of this arrangement. Thus the lattice of ideals is a partial order (a lattice) on these permutations. By definition, this lattice orders the inversion sets of the permutations by inclusion, so it is a sublattice of the weak Bruhat order. Since it is a lattice of ideals, by Birkhoff's Theorem it is distributive. ■

Theorem 2 and its proof suggest a new algorithm for constructing acyclic sets of the Abello/Chameni-Nembua kind. Start with a maximal chain in the weak Bruhat order; derive the natural partial order from its corresponding arrangement of pseudolines; construct the lattice of ideals of the natural partial order.

Now we show that the alternating scheme also fits naturally in the framework just described.

Theorem 3 *The alternating scheme is the set of permutations visited by an equivalence class of maximal reduced decompositions.*

Proof Recall that the alternating scheme is the set of U_A constraints, where

$$U_A = \{\{i, j, k\} | 1 \leq i < j < k \leq n \text{ and } j \text{ is odd}\}. \quad (16)$$

We will show that $U_A \in \mathbb{B}(n, 2)$. In light of Theorems 1 and 2 and their proofs, this will prove the Theorem. Part of Ziegler's main theorem in [23,

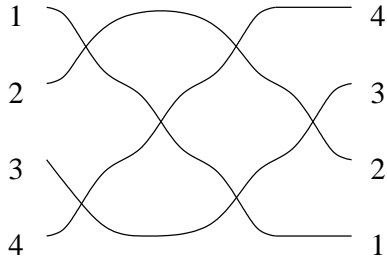

Fig. 8 The alternating scheme

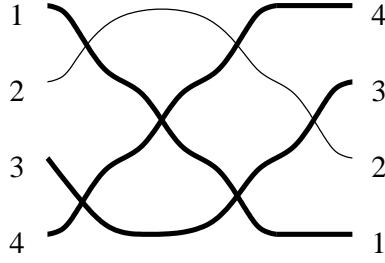

Fig. 9 Strings 1, 3 and 4 make an upward pointing triangle

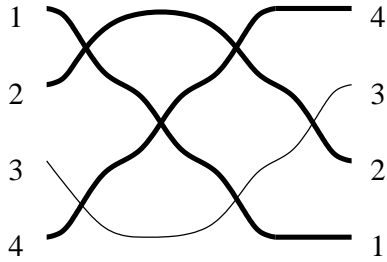

Fig. 10 Strings 1, 2 and 4 make a downward pointing triangle

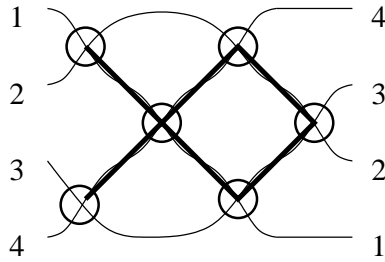

Fig. 11 The natural partial order on the set of crossings

Theorem 4.1, part B] provides a simple characterization¹⁷ of subsets of $\binom{[n]}{3}$ that are elements of $\mathbb{B}(n, 2)$: a set of three-subsets $U \subseteq \binom{[n]}{3}$ is an element of $\mathbb{B}(n, 2)$ if, and only if, for any $\{p, q, r, s\}$ with $1 \leq p < q < r < s \leq n$ the intersection of U with the quadruple $(\{p, q, r\}, \{p, q, s\}, \{p, r, s\}, \{q, r, s\})$ is either a beginning or an ending segment of the quadruple. We now show that this holds for U_A : if q and r are even, the intersection is empty; if they are both odd, the intersection is all four elements; if q is odd, but r even, then the intersection is the first two elements; in the symmetric case it is the last two. Thus we have verified that $U_A \in \mathbb{B}(n, 2)$. ■

We illustrate the above results with the alternating scheme for $n = 4$. The arrangement of pseudolines corresponding to it is shown in Figure 8.

We can find the inversion set (and thus the element of the higher Bruhat order $\mathbb{B}(n, 2)$) that this arrangement corresponds to: the pseudolines 1, 3 and 4 make a triangle that points up (Figure 9), and so $\{1, 3, 4\}$ is part of the inversion set corresponding to any maximal reduced decomposition represented by this arrangement. Similarly, $\{2, 3, 4\}$ is an inversion. On the other hand, the pseudolines 1, 2 and 4 make a downward pointing triangle (Figure 10), and $\{1, 2, 4\}$ is not an inversion. Similarly, $\{1, 2, 3\}$ is not an inversion. Thus this arrangement corresponds to the element $\{\{1, 3, 4\}, \{2, 3, 4\}\}$ of $\mathbb{B}(n, 2)$. The natural partial order of this wiring diagram is shown in Figure 12, and Figure 11 shows it embedded in the arrangement.

¹⁷ Ziegler’s characterization is for higher Bruhat orders $\mathbb{B}(n, k)$ — we state it for $\mathbb{B}(n, 2)$ only.

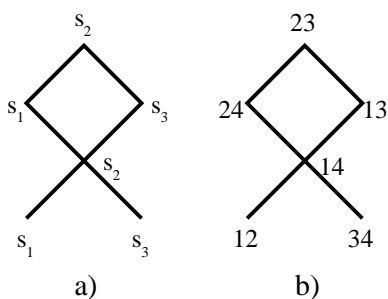

Fig. 12 The natural partial order

The lattice of ideals of the natural partial order is shown in part b) of Figure 13. Part a) of Figure 13 illustrates that each ideal may be identified with the initial segment of a (non-unique) maximal reduced decomposition corresponding to the arrangement. As shown above, the maximal reduced decompositions identified with the top element in part a) of the Figure constitute an equivalence class. If we replace the initial segments of the maximal reduced decompositions with the permutations they generate, i.e. if we identify each element of the lattice with a permutation, we get the sublattice of the weak Bruhat order $\mathbb{B}(4, 1)$ described in Theorem 2 — this sublattice is shown in part c) of Figure 13 and is highlighted in Figure 2.

3.1 Enumerating the alternating scheme

Our method of enumerating the permutations that satisfy the alternating scheme of Fishburn [13] amounts to deriving the cardinality of the lattice of ideals of the natural partial order of the arrangement of pseudolines that corresponds to the inversion sets U_A (see (13) on p. 11). For example, the arrangement in Figure 8 corresponds to the inversion set of the alternating scheme when $n = 4$: $\{\{1, 3, 4\}, \{2, 3, 4\}\}$. Thus we can enumerate the permutations satisfying the alternating scheme by counting the ideals of the poset in Figure 12. There are nine such ideals, and, indeed, the cardinality of the alternating scheme is nine when $n = 4$. Because the natural partial order of an arrangement of pseudolines corresponding to the alternating scheme is very regular, we can pursue the same strategy to derive a general formula.

We illustrate the approach for $n = 8$. The arrangement corresponding to the alternating scheme is shown in Figure 14. The regularity of the diagram is not coincidental: every arrangement corresponding to the alternating scheme for even n will look like this. To see why, notice that even numbered pseudolines must move up first, because they are in the middle of non-inversions. Then they must cross every smaller pseudoline before they cross any of the larger ones. Odd pseudolines must move down first, because they are in the middle of inversions. Then they must cross every

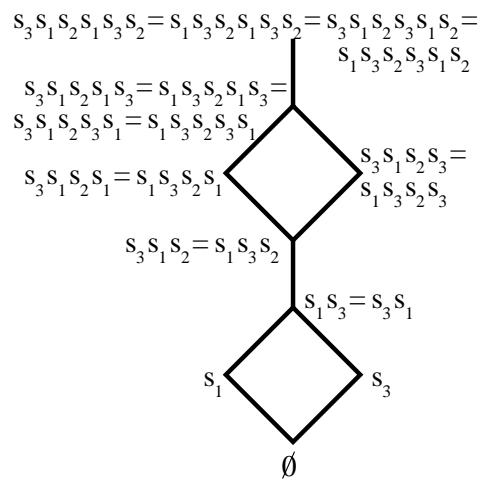

a)

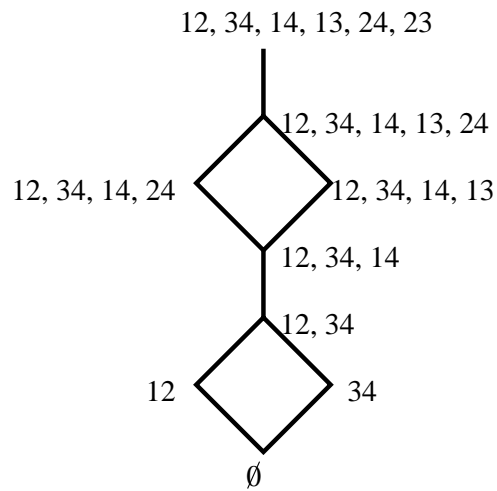

b)

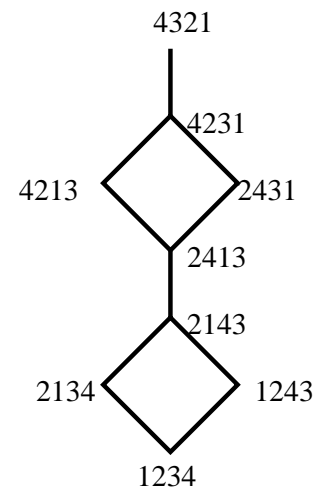

c)

Fig. 13 The lattice of ideals of the natural partial order

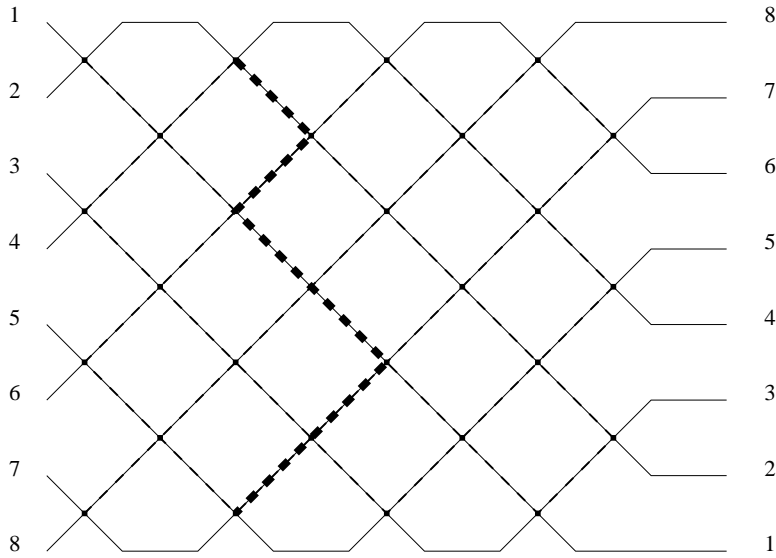

Fig. 14 The arrangement for the alternating scheme when $n = 8$. The natural partial order is highlighted. An ideal can be identified by its upper boundary.

larger pseudoline before they cross any of the smaller ones. The natural partial order is highlighted in Figure 14. To enumerate the alternating scheme, we must count the ideals of this poset. An ideal can be identified by its *upper boundary*, as shown in Figure 14. The empty ideal, however, cannot be represented by such a boundary, and neither can any of the ideals consisting of fewer than four of the elements in the bottom rank. To correct this, we add two extra ranks at the bottom, extending the arrangement and the natural partial order as in Figure 15. We can represent the empty ideal by the boundary shown in Figure 15. Now every ideal may be represented by its boundary, that is, by a lattice path in the arrangement that starts on the top and proceeds downward until it reaches the bottom. In other words, every ideal corresponds to a path from one of the circled points on the top to one of those circled on the bottom (Figure 16). This means that enumerating the set of permutations that satisfy the alternating scheme amounts to counting the paths from top to bottom in the extended version of the natural partial order of the arrangement. We use standard lattice path enumeration techniques to sum these paths, and then manipulate the resulting sums to obtain the formula in the following Theorem.

Theorem 4 *The cardinality of the alternating scheme is*

$$A_n = 2^{n-3} (n + 3) - \begin{cases} \binom{\frac{n-2}{2}}{\frac{n-2}{2}-1} \left(n - \frac{3}{2}\right) & \text{for even } n \\ \binom{\frac{n-1}{2}}{\frac{n-1}{2}} \left(\frac{n-1}{2}\right) & \text{for odd } n \end{cases} \quad (17)$$

Proof We will prove the theorem for even n — the case of odd n is very similar. The extended version of the natural partial order of the arrangement

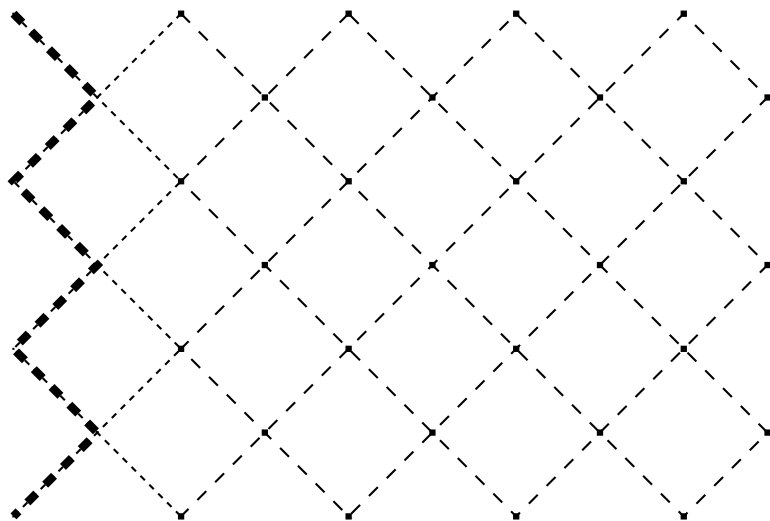

Fig. 15 The natural partial order, extended so that the empty ideal can be represented as a lattice path (drawn thick)

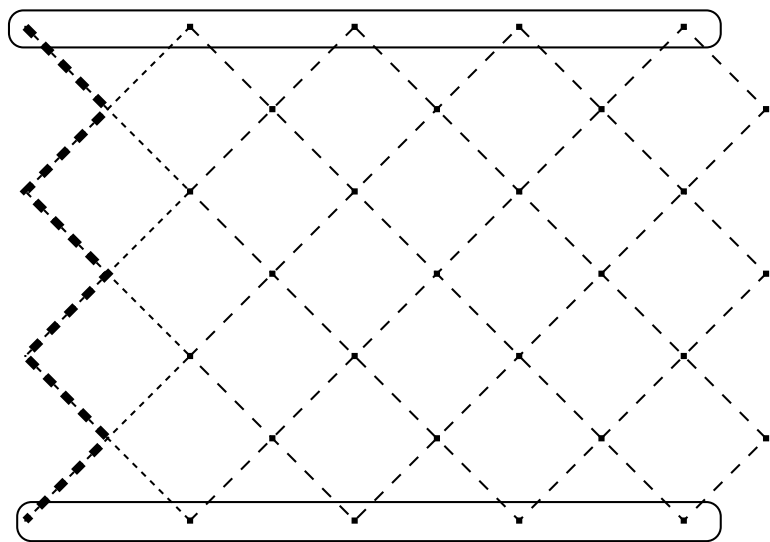

Fig. 16 Representing ideals as paths

for n even will be just like that shown in Figure 16, with $\frac{n}{2}+1$ circled starting points on the top (and the same number of ending points on the bottom). The length of a path will be $n - 2$. Using standard lattice path counting techniques (explained below), we will obtain

$$A_n = A_n^1 - A_n^2 - A_n^3 \tag{18}$$

where

$$\begin{aligned} A_n^1 &:= \sum_{i=1}^{\frac{n}{2}+1} \sum_{j=1}^{\frac{n}{2}+1} \binom{n-2}{\frac{n}{2}-1+|i-j|} \\ A_n^2 &:= \sum_{i=1}^{\frac{n}{2}+1} \sum_{j=1}^{\frac{n}{2}+1} \binom{n-2}{\frac{n}{2}+i+j-2} \\ A_n^3 &:= \sum_{i=1}^{\frac{n}{2}+1} \sum_{j=1}^{\frac{n}{2}+1} \binom{n-2}{\frac{n}{2}+n-i-j+3}. \end{aligned} \quad (19)$$

A_n^1 counts the paths that start from some crossing on the top and end at a crossing on the bottom. We must subtract A_n^2 and A_n^3 , the cardinalities of the paths that go beyond the diagram (Figure 16) on the right or on the left. The above formulae for A_n^2 and A_n^3 follow from the *reflection principle* [21, p. 130].

Each of these can be summed using two consequences of the Binomial Theorem (for even N):

$$\sum_{k=\frac{N}{2}+1}^N \binom{N}{k} = \frac{1}{2} \left[2^N - \binom{N}{\frac{N}{2}} \right] \quad (20)$$

and

$$\sum_{k=\frac{N}{2}+1}^N k \binom{N}{k} = \frac{N}{2} 2^{N-1}. \quad (21)$$

We now derive the formula for A_n^1 :

$$\begin{aligned} A_n^1 &= \sum_{i=1}^{\frac{n}{2}+1} \sum_{j=1}^{\frac{n}{2}+1} \binom{n-2}{\frac{n}{2}-1+|i-j|} \\ &= -\left(\frac{n}{2}+1\right) \binom{n-2}{\frac{n}{2}-1} + \sum_{k=0}^{\frac{n}{2}} 2 \binom{n-2}{\frac{n}{2}+1-k} \binom{n-2}{\frac{n}{2}-1+k} \end{aligned} \quad (22)$$

where here we have used the fact that $|i-j|$ takes on each value k in the range $[0, \frac{n}{2}]$, and it takes on each such value k (except for $k=0$) exactly $2 \binom{n}{2} + 1 - k$ times. Continuing, one has

$$\begin{aligned} A_n^1 &= -\left(\frac{n}{2}+1\right) \binom{n-2}{\frac{n}{2}-1} + \sum_{l=\frac{n}{2}+1}^{n-2} 2(n-l) \binom{n-2}{l} \\ &= -\left(\frac{n}{2}+1\right) \binom{n-2}{\frac{n}{2}-1} + 2n \left(2^{n-3} + \frac{1}{2} \binom{n-2}{\frac{n}{2}-1} \right) - \\ &\quad - (n-2) 2^{n-3} - (n-2) \binom{n-2}{\frac{n}{2}-1} \\ &= 2^{n-3} (n+2) + \left(1 - \frac{n}{2}\right) \binom{n-2}{\frac{n}{2}-1}. \end{aligned}$$

Similar algebraic manipulation gives us

$$A_n^2 = \left(\frac{n}{4} - \frac{1}{2}\right) \binom{n-2}{\frac{n}{2}-1} \quad (23)$$

$$A_n^3 = 2^{n-3} \binom{n}{2} - \frac{n}{4} \left(2^{n-2} - \binom{n-2}{\frac{n}{2}-1}\right). \quad (24)$$

Thus we have

$$\begin{aligned} A_n &= A_n^1 - A_n^2 - A_n^3 \\ &= 2^{n-3} (n+3) - \binom{n-2}{\frac{n}{2}-1} \binom{n-3}{\frac{n}{2}}. \end{aligned} \quad (25)$$

3.2 A conjecture and some comments on upper and lower bounds

Fishburn conjectured [12, Conjecture 2] that among acyclic sets that do not use an N_2 (or “never second”) constraint, the alternating scheme has maximum cardinality. The following conjecture is a weakening of his.

Conjecture 1 Among acyclic sets that are the permutations visited by some equivalence class of maximal reduced decompositions, the alternating scheme has maximum cardinality.

This conjecture is based on intuition from enumerating the alternating scheme in the particular way we described above. Fishburn has shown that for $n \leq 6$, the alternating scheme achieves maximum cardinality, which implies Conjecture 1 above for those cases. We have checked that Conjecture 1 also holds for $n = 7$.

Abello showed [1] that, for n alternatives, acyclic sets containing a maximal chain in the weak Bruhat order $\mathbb{B}(n, 1)$ have cardinality less than $C_n = \frac{1}{n+1} \binom{2n}{n}$, the n th Catalan number. If our Conjecture 1 is true, the maximum cardinality of such acyclic sets is much smaller; in fact, asymptotically $A_n/C_n \rightarrow 0$. (Using Stirling’s Approximation, it is easy to see that asymptotically $A_n \approx 2^n n (1 - \sqrt{\frac{2}{\pi n}}) \approx 2^n n$, while $C_n \approx \frac{4^n}{\sqrt{\pi n}^{\frac{3}{2}}}$.)

The best lower bound known is due to Fishburn [12]. Suppose we have an acyclic set of cardinality K on k alternatives. Fishburn showed in [12]¹⁸, using the *replacement scheme*, that for all large n , an acyclic set of cardinality $\left(K^{\frac{1}{k-1}}\right)^n$ can be constructed. Listing A_n up to 25 with the corresponding factors $(A_n)^{\frac{1}{n-1}}$, he concludes that the best known lower bound is given by $(A_{11})^{\frac{1}{10}} = 2.17082$: acyclic sets of cardinality 2.17082^n can be constructed for all large n . Using (17), we can confirm that this is indeed the best lower bound obtainable from the alternating scheme using Fishburn’s method. It is easy to see that A_{n+2}/A_n is between 4 and 5, quickly approaching 4. Thus the factor $(A_n)^{\frac{1}{n-1}}$ is monotonically decreasing after $n = 11$, where it achieves its maximum.

¹⁸ See also [7].

References

1. James Abello. The weak Bruhat order of s_σ , consistent sets, and Catalan numbers. *SIAM Journal of Discrete Mathematics*, 4(1):1–16, February 1991.
2. Anders Björner and Francesco Brenti. *Combinatorics of Coxeter Groups*. Graduate Texts in Mathematics. Springer, 2005.
3. Anders Björner, Michel Las Vergnas, Bernd Sturmfels, Neil White, and Günter M. Ziegler. *Oriented Matroids*. Number 46. in Encyclopedia of Mathematics and its Applications. Cambridge University Press, 1993.
4. Jean-Marie Blin. The General Concept of Multidimensional Consistency: Some Algebraic Aspects of the Aggregation Problem. *Northwestern University CMS–EMS Discussion Papers*, no. 12, 1972.
5. C. Chameni-Nembua. Règle majoritaire et distributivité dans le permuttoedre. *Math. Inf. Sci. hum.*, 27(108):5–22, 1989.
6. Marquis de Condorcet. *Essai sur l'application de l'analyse à la probabilité des décisions rendues à la pluralité des voix*. Paris, 1785.
7. John Craven. Further Notes on Craven's Conjecture. *Social Choice and Welfare*, 11:283–285, 1994.
8. John Craven. Majority-consistent preference orderings. *Social Choice and Welfare*, 13:259–267, 1996.
9. S. Felsner and H. Weil. A theorem on higher Bruhat orders. *Discrete and Computational Geometry*, 23(1):121–127, 2000.
10. Stefan Felsner. On the number of arrangements of pseudolines. *Discrete & Computational Geometry*, 18:257–267, 1997.
11. Stefan Felsner and Günter M. Ziegler. Zonotopes associated with higher Bruhat orders. *Discrete Mathematics*, 241:301–312, 2001.
12. Peter C. Fishburn. Acyclic sets of linear orders. *Social Choice and Welfare*, 14:113–124, 1997.
13. Peter C. Fishburn. Acyclic sets of linear orders: A progress report. *Social Choice and Welfare*, 19:431–447, 2002.
14. J. E. Goodman and R. Pollack. Semispaces of configurations, cell complexes of arrangements. *J. Combinatorial Theory, Ser. A*, 37:257–293, 1984.
15. Branko Grünbaum. *Arrangements and Spreads*. Number 10 in Regional Conference Series in Mathematics. American Mathematical Society, 1972.
16. G. Th. Guilbaud and P. Rosenstiehl. Analyse algébrique d'n scrutin. *Mathématiques et Sciences Humaines*, 4:9–33, 1963.
17. Yu. I. Manin and V. V. Schechtman. Higher Bruhat orders, related to the symmetric group. *Functional Analysis Applications*, 20:148–150, 1986.
18. Yu. I. Manin and V. V. Schechtman. Arrangements of hyperplanes, higher braid groups and higher Bruhat orders. In J. Coates et al., editor, *Algebraic Number Theory — in honor of K. Iwasawa*, volume 17 of *Advanced Studies in Pure Mathematics*, pages 289–308. Kinokuniya Company / Academic Press, 1989.
19. Ran Raz. VC-dimension of sets of permutations. *Combinatorica*, 20(2):241–255, 2000.
20. Amartya K. Sen. A possibility theorem on majority decisions. *Econometrica*, 34(2):491–499, April 1966.
21. Dennis Stanton and Dennis White. *Constructive Combinatorics*. Springer-Verlag, 1986.

22. Benjamin Ward. Majority voting and alternative forms of public enterprises. In J. Margolis, editor, *The Public Economy of Urban Communities*. Johns Hopkins Press, Baltimore, 1965.
23. Günter M. Ziegler. Higher Bruhat orders and cyclic hyperplane arrangements. *Topology*, 32(2):259–279, 1993.