

Friezes over $\mathbb{Z}[\sqrt{2}]$ and $\mathbb{Z}[\sqrt{3}]$

Amy Tao, Zhichun Joy Zhang

Summer 2021

Abstract

A frieze on a polygon is a map from the diagonals of the polygon to an integral domain that respects the Ptolemy relation. Motivated by Holm and Jørgensen's study of friezes from gluing together regular sub-polygons, we study friezes over the integral domain $\mathbb{Z}[\sqrt{2}]$ and $\mathbb{Z}[\sqrt{3}]$. The rings $\mathbb{Z}[\sqrt{2}]$ and $\mathbb{Z}[\sqrt{3}]$ correspond to dissecting a polygon into triangles and squares and into triangles and (regular) hexagons, respectively. This was a generalization of work by Conway and Coxeter, who found that friezes over positive integers on an n -gon are in bijection with triangulations of an n -gon. In particular, we are interested in *unitary* friezes on a polygon. A frieze is unitary if there exists a triangulation of the underlying polygon such that every arc in the triangulation has a weight in the frieze that is a unit in the respective integral domain. Conway and Coxeter found that all friezes on a polygon over positive integers are unitary. We explore the characterization of unitary friezes on a polygon over $\mathbb{Z}[\sqrt{2}]$ and $\mathbb{Z}[\sqrt{3}]$. While in $\mathbb{Z}[\sqrt{2}]$ we find a whole family of dissections involving squares and triangles that give rise to a unitary frieze, we claim that in $\mathbb{Z}[\sqrt{3}]$ the only unitary friezes come from triangulations - i.e. we cannot use a hexagon in the dissection. We also show that the family of dissections giving unitary friezes in $\mathbb{Z}[\sqrt{2}]$ has connections to well-known, infinite continued fractions.

1 Introduction

In this paper, we will study friezes. A frieze, \mathcal{F} , most generally can be defined as a map from a cluster algebra $\mathcal{A}(Q)$ to an integral domain R . When the cluster algebra arises from a marked surface (S, M) , we can equivalently view a frieze as a map on the arcs on (S, M) , subject to certain relations. We will mainly take this latter point of view.

We will only be interested in *positive* friezes, which are friezes that send each cluster variable or arc on the relevant surface to a positive number. We will also look at *unitary* friezes, which are friezes such that all cluster variables in one cluster in $\mathcal{A}(Q)$ are sent to units in R . When $\mathcal{A}(Q)$ is of surface type, this means all arcs in one triangulation have unit weight under the frieze.

The most well-studied set of friezes are positive, *integral* friezes, where $R = \mathbb{Z}$. Conway and Coxeter's original work in [3] showed that positive, integral friezes over cluster algebras of type A are unitary and are in bijection with triangulations of a polygon (see Theorem 4). We can see this bijection by associating to each frieze its (necessarily unique) triangulation with all arcs of weight 1.

Gunawan and Schiffler in [8] showed that positive, integral friezes on cluster algebras of type $\tilde{A}_{p,q}$ also must be unitary. These arise from triangulations of annuli with p marked points on one boundary component and q on the other. However, the appendix of [2] shows that the same is not true for friezes on cluster algebras type D , which arise from punctured polygons. Fontaine and Plamondon count all positive integral friezes of type D_n in [7].

Recently, Holm and Jørgensen investigated friezes over other integral domains which correspond to dissections of polygons [9]. In particular, they found an injection from dissections of a polygon into polygons of size $\{p_1, \dots, p_n\}$ to friezes on the polygon over a ring determined by the numbers p_1, \dots, p_n . When the dissection divides the polygon into all sub-polygons of the same size, this becomes a bijection. Exploring the image of this map for more general dissections is a main motivation for this project.

In Section 2, we provide the background of the problem. We introduce cluster algebras in 2.1, friezes and frieze patterns in 2.2, friezes from dissections in 2.3, and some tools to compute friezes in 2.4.

In Section 3, we present our results. In 3.1, we discuss the relationship between four different types of friezes over \mathbb{Z} . In 3.2, we prove that the set of $\mathbb{Z}[\sqrt{2}] \geq 1$ friezes is equal to the set of friezes from dissection for a quadrilateral, but for a hexagon, there is at least one unitary frieze that does not come from a dissection. In 3.3, we prove a recursive formula that counts the number of dissections of an n -gon into triangles and quadrilaterals. In 3.4, we explain the Sage functions to compute friezes from dissection. In 3.5, we prove that certain families of dissections into triangles and squares only produce unitary or not-unitary friezes. And we make progress in proving the conjecture that a dissection into triangles and quadrilaterals produce a unitary frieze if and only if the dissection is a gluing of towers.

Finally, in Section 4, we discuss some future directions that can be taken after the project.

2 Preliminaries

2.1 Cluster algebras

Cluster algebras were introduced by Fomin and Zelevinsky in 2002 [6]. We provide some brief background on cluster algebras and later we specialize to cluster algebras from surfaces. For a more detailed treatment, see the survey by Lauren Williams [11].

Let K be a field. A cluster algebra of rank n is a subalgebra of $K(x_1, \dots, x_n)$, the algebra of rational functions in x_1, \dots, x_n with coefficients in K . A cluster algebra is determined by what a seed.

Definition A **seed** is a pair (\underline{X}, Q) where $\underline{X} = \{v_1, \dots, v_n\}$ is a free generating set for $K(x_1, \dots, x_n)$ and Q is a quiver on the vertices $[n] = \{1, \dots, n\}$.

A **quiver** is a directed graph without self-loops or directed 2-cycles.

We call \underline{X} a **cluster** and each $v_i \in K(x_1, \dots, x_n)$ a **cluster variable**.

Given a seed (\underline{X}, Q) and any vertex $k \in [n]$, there is an operation known as mutation at k , denoted μ_k , which affects the generating set of rational functions \underline{X} and the quiver Q simultaneously:

$$\mu_k(\underline{X}, Q) = (\mu_k(\underline{X}), \mu_k(Q)).$$

- The result of mutating the generating set of rational functions is $\mu_k(\underline{X}) = \{v'_1, \dots, v'_n\}$ where

$$v'_i = \begin{cases} v_i & \text{for } i \neq k \\ \frac{\prod_{j \rightarrow k} v_j + \prod_{k \rightarrow j} v_j}{v_k} & \text{for } i = k. \end{cases}$$

Note that only the k^{th} cluster variable is changed.

- The quiver Q is mutated at the vertex k according to the following algorithm:
 1. For all paths $i \rightarrow k \rightarrow j$, add an arrow $i \rightarrow j$.
 2. Reverse all arrows incident to k .
 3. Remove any 2-cycles that formed.

One can check that mutation is an involution on both elements of the seed.

Example Consider the seed $(\{x_1, x_2\}, 1 \rightarrow 2)$. Mutating at 1, we get the seed $(\{\frac{1+x_2}{x_1}, x_2\}, 1 \leftarrow 2)$. Since mutation is an involution, to produce new cluster variables, we must alternate the index we mutate at. Mutating at 2, we have $(\{\frac{1+x_2}{x_1}, \frac{1+x_1+x_2}{x_1x_2}\}, 1 \rightarrow 2)$. Further mutating at 1 gives $(\{\frac{1+x_1}{x_2}, \frac{1+x_1+x_2}{x_1x_2}\}, 1 \leftarrow 2)$. Then mutating at 2, we have $(\{\frac{1+x_1}{x_2}, x_1\}, 1 \rightarrow 2)$. Mutating one more time at 1, we magically recover $(\{x_2, x_1\}, 1 \leftarrow 2)$ which has the same cluster variables as the initial seed. As such, continuing to mutate at 1 and 2 will not produce any new cluster variables.

Definition The **cluster algebra** $\mathcal{A}(Q)$ is the subalgebra of $K(x_1, \dots, x_n)$ generated by all cluster variables obtained from mutating $(\{x_1, \dots, x_n\}, Q)$.

Example From the previous example, we see that $\mathcal{A}(1 \rightarrow 2) = K \left[x_1, x_2, \frac{x_1+1}{x_2}, \frac{x_2+1}{x_1}, \frac{x_1+x_2+1}{x_1x_2} \right]$. Note that the cluster algebra here is the subalgebra of $K(x_1, \dots, x_n)$ generated by these five polynomials, meaning that we take all polynomials in these five but do not allow rational functions in them.

Below is a celebrated result in cluster algebras.

Theorem 1 (Fomin and Zelevinsky [6]) Every cluster variable is a Laurent polynomial in the initial cluster variables x_1, x_2, \dots, x_n . This is known as the Laurent phenomenon.

Note that because of the Laurent phenomenon and linearity, a frieze f is fully determined by where it maps the cluster variables of any single cluster. In other words, given a cluster $\{v_1, \dots, v_n\}$, if we stipulate an element in the integral domain to be the image of each cluster variable, then it uniquely extends to a map on all cluster variables. However, unless the image values are chosen wisely, the extended map may not be a frieze in that outputs of general cluster variables may not land in the integral domain but rather be "fractions". Therefore it is special when specifying a cluster to a particular n -tuple of integral domain elements does give a frieze.

Definition Let $\underline{X} = (x_1, \dots, x_n)$ be a cluster of $\mathcal{A}(Q)$. The n -tuple of nonzero elements from the integral domain $(a_1, \dots, a_n) \in (R_{\neq 0})^n$ is a frieze vector with respect to \underline{X} if the map f defined by $f(x_i) = a_i$ has values in R .

2.1.1 Cluster Algebras from Surfaces

In 2008, Fomin—Shapiro—Thurston introduced a more geometric perspective of cluster algebras through what is known as the surface model [5].

Let S be a connected orientable 2-dimensional Riemann surface with boundary. Let M be a set of marked points in the closure of S . We assume that M is nonempty and that there is at least one marked point on each connected component of the boundary of S . We further exclude the particular possibilities for the pair (S, M) that are stated in Definition 2.1 [5].

Example Polygons are marked surfaces, with the marked points being the vertices on the boundary. Other examples of marked surfaces include once-punctured polygons and annuli.

Definition An **arc** on (S, M) is a curve with endpoints at marked points, having no self-intersections and not intersecting the boundary except at endpoints. A **puncture** is a marked point in the interior of a surface.

We consider arcs up to isotopy of relative endpoints.

Definition A **triangulation** of a marked surface (S, M) is a maximal set of arcs that do not intersect.

Fomin—Shapiro—Thurston showed that such marked surfaces have a cluster algebra structure [5]. The following bijections relate geometric information to traditional cluster algebra language:

$$\begin{aligned} \text{triangulations} &\leftrightarrow \text{clusters} \\ \text{arcs} &\leftrightarrow \text{cluster variables} \\ \text{flipping arcs} &\leftrightarrow \text{mutation.} \end{aligned}$$

Here “flipping arcs” denotes the operation on marked surfaces depicted below where we flip the diagonal of any quadrilateral.

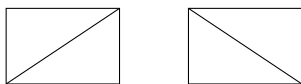

Notably for cluster algebras coming from surfaces, the second bijection means that instead of defining a frieze as a homomorphism from a cluster algebra to an integral domain, we can view a frieze as an assignment of an integral domain element to every arc on the surface. We formalize this perspective in the next subsection.

2.1.2 Finite Type Classification

Definition A cluster algebra is of **finite type** if it has finitely many seeds.

Example One can see that cluster algebra from the example in subsection 2.1 with initial seed $(\{x_1, x_2\}, 1 \rightarrow 2)$ is of finite type.

We describe two classes of finite type cluster algebras.

Definition Let (S, M) be an unpunctured $(n+3)$ -gon where $n \geq 1$. We say that the cluster algebra from this surface is of **type A_n** .

Definition Let (S, M) be a once-punctured n -gon where $n \geq 4$. We say that the cluster algebra from this surface is of **type D_n** .

2.2 Friezes and frieze patterns

In this section, we define friezes and frieze patterns. We begin by defining a frieze and we will later see that these are in bijection with frieze patterns in certain situations.

2.2.1 Friezes on a polygon

A frieze can be defined most generally using the language of cluster algebras.

Definition Let R be an integral domain and let Q be a quiver. A **frieze of type Q** is a homomorphism $f : \mathcal{A}(Q) \rightarrow R$ where \mathcal{A} is the cluster algebra associated to the quiver Q .

When working from cluster algebras from surfaces, we can visualize this definition via the the surface model. In particular, we can view a frieze as a map assigning weights to arcs in a marked surface. This is the point of view that we will use for the bulk of the paper. Note that while surface model holds in much greater generality, in this paper we will always take the surface to be an unpunctured polygon. We begin by defining some geometric terminology in this simpler context.

A **polygon** or **n -gon** is a finite set $V = \{0, 1, \dots, n-1\}$ of vertices together with a cyclic ordering on V . If α is a vertex in V , we denote its predecessor in the cyclic ordering by α^- and its successor as α^+ . Arcs in the polygon are sets $\{\alpha, \beta\}$ of two vertices. We say that two arcs $\{\alpha, \beta\}$ and $\{\gamma, \delta\}$ **cross** if $\alpha, \beta, \gamma, \delta$ are four distinct vertices in V that in the cyclic ordering satisfy $\alpha < \gamma < \beta < \delta$ or $\alpha < \delta < \beta < \gamma$.

Definition Let P be a polygon with vertex set V . A *frieze on P* is a map $f : V \times V \rightarrow [0, \infty)$ where

1. $f(\alpha, \beta) = 0 \iff \alpha = \beta$
2. $f(\alpha, \alpha^+) = 1$
3. $f(\alpha, \beta) = f(\beta, \alpha)$
4. If $\{\alpha, \beta\}$ and $\{\gamma, \delta\}$ are crossing diagonals of P , then we have the Ptolemy relation $f(\alpha, \beta)f(\gamma, \delta) = f(\alpha, \gamma)f(\beta, \delta) + f(\alpha, \delta)f(\gamma, \beta)$.

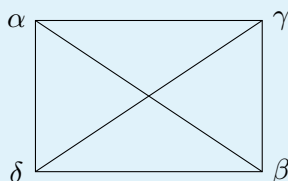

Example The picture below shows all of the arcs inside a pentagon.

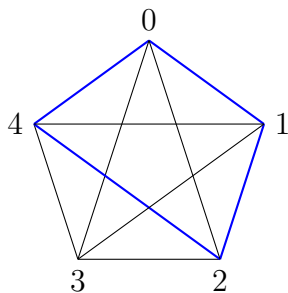

Because of condition 3 of being a frieze, it suffices to know $f(\alpha, \beta)$ for $\alpha \leq \beta$. To satisfy conditions 1 and 2 of being a frieze, we must have:

$$f(0, 0) = f(1, 1) = \dots = f(4, 4) = 0$$

$$f(0, 1) = f(1, 2) = f(2, 3) = f(3, 4) = 1.$$

The following non-trivial edge weights satisfy all Ptolemy relations between them and thus give a frieze on a pentagon: $f(0, 2) = f(0, 3) = 1$, $f(1, 3) = f(2, 4) = 2$ and $f(1, 4) = 3$. For example, the arcs in the blue quadrilateral must satisfy $f(1, 4) \cdot f(0, 2) = f(0, 1) \cdot f(2, 4) + f(0, 4) \cdot f(1, 2)$ and one can verify that this holds for the specified weights.

Example Consider the *Euclidean frieze*

$$\ell_p(\alpha, \beta) = \text{the length of the line segment from } \alpha \text{ to } \beta.$$

This gives a frieze on any regular p -gon. Namely the length from a vertex to itself is zero, the sides have length one, length is symmetric and the Ptolemy relation it has to satisfy becomes Ptolemy's theorem, because a regular polygon can always be circumscribed.

2.2.2 Frieze patterns

There is a related object called a frieze pattern. Frieze patterns were originally defined by Coxeter in [4]. They considered finite integral frieze patterns, but we can more generally take entries from any ring.

Definition A **frieze pattern of width** $n \in \mathbb{Z}_{\geq 0}$ has $n + 4$ horizontally infinite rows of non-negative real numbers (or more generally elements of a ring), where every other row is staggered by one. The top-most row and bottom-most row are all zeroes. The second-top and second-bottom rows are all ones. Moreover, every diamond $\begin{matrix} & a & \\ b & & c \\ & d & \end{matrix}$ must satisfy the **diamond relation** $ad - bc = 1$.

We state without proof the relationship between friezes on a polygon and frieze patterns. It uses the following indexing

$$\begin{array}{cccccc}
0 & & 0 & & 0 & & 0 & & 0 \\
& 1 & & 1 & & 1 & & 1 & \\
a_{(0,2)} & & a_{(1,3)} & & a_{(2,4)} & & a_{(3,5)} & & a_{(4,6)} \\
& a_{(0,3)} & & a_{(1,4)} & & a_{(2,5)} & & a_{(3,6)} & & a_{(4,7)} \\
a_{(-1,3)} & & a_{(0,4)} & & a_{(1,5)} & & a_{(2,6)} & & a_{(3,7)} \\
\vdots & & \vdots & & \vdots & & \vdots & & \vdots
\end{array}$$

where the topmost row of zeros is indexed $a_{(i,i)}$ for all i .

Theorem 2 ([9]) Let P be an $(n + 3)$ -gon with vertices $V = \{0, 1, \dots, n + 2\}$. There is a bijection $F \mapsto f$ from frieze patterns of width n to friezes on P where $f : V \times V \rightarrow [0, \infty)$ is defined by

$$f(\alpha, \beta) = \begin{cases} F(\alpha, \beta) & \text{for } \alpha \leq \beta \\ F(\beta, \alpha) & \text{for } \alpha > \beta \end{cases}$$

We remark that in light of this theorem, the diamond relation for frieze patterns is actually a special case of the Ptolemy relation. Overall this theorem allows us to use the terms “frieze” and “frieze pattern” interchangeably. We mostly focus on friezes on a polygon, but sometimes depict them as a frieze pattern for convenience.

2.2.3 Integer friezes from Conway-Coxeter

Conway and Coxeter studied frieze patterns with non-negative integral entries. They showed a correspondence between frieze patterns of this kind to triangulations of polygons.

Theorem 3 Frieze patterns of width n of non-negative integers are in bijection with the triangulations of a convex $(n + 3)$ -gon. If (a_1, \dots, a_n) is the repeating cycle of the first non-trivial row of the frieze, then a_i is the number of triangles adjacent to the i^{th} vertex in the corresponding triangulated n -gon.

This is response 27 in [3] and Theorem 4.3 in [10].

Example Consider the triangulation of a pentagon depicted below.

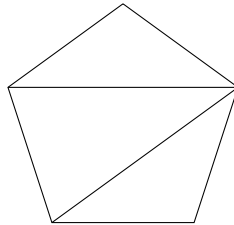

According to the bijection in [3], it corresponds to the following integral frieze pattern.

$$\begin{array}{cccccc}
0 & 0 & 0 & 0 & 0 & 0 \\
& 1 & 1 & 1 & 1 & 1 \\
1 & & 3 & & 2 & & 2 & & 1 \\
& 2 & & 2 & & 1 & & 3 & & 1 \\
1 & & 1 & & 1 & & 1 & & 1 \\
& 0 & & 0 & & 0 & & 0 & & 0
\end{array}$$

Conway and Coxeter also proved that every frieze of type A is unitary.

Definition A frieze on a polygon is **unitary** if there exists a triangulation of the polygon such that the value of each arc in the triangulation is a unit.

We revisit the proof by Conway-Coxeter.

Definition A k -**diagonal** in a polygon skips k vertices to one side. By symmetry in an n -gon, a k -diagonal is the same as an $n - k - 2$ -diagonal.

Lemma 1 Given an n -gon with boundary weights all 1, there exists a 1-diagonal with weight 1.

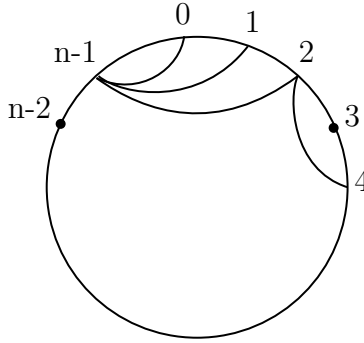

Proof. We label the vertices of the n -gon cyclically as $0, 1, \dots, n - 1$. Let the weight of the arc from vertex $n - 1$ to vertex $j \neq n - 1$ be f_j and the weight of the 1-diagonal skipping vertex j be a_j . For a contradiction, suppose that all 1-diagonals have weights strictly greater than 1. We induct on the number of sides of the polygon.

The base case is $n = 4$ because $n = 3$ has no 1-diagonals. Consider the quadrilateral with vertices $0, 1, 2, n - 1$. By the Ptolemy relations, $f_1 a_1 = f_2 \cdot 1 + f_0 \cdot 1 = f_2 + 1$. Since $a_1 \geq 2$, $2f_1 \leq f_2 + 1$, which implies that $f_2 - f_1 \geq f_1 - 1$. Since $f_1 > 1$ and $f_1 \in \mathbb{Z}_+$, we have that $f_2 > f_1$.

For the inductive step, suppose we have $f_{i-1} > f_{i-2}$ for $3 \leq i \leq n - 2$. Note that the arcs with weights f_{i-1} and a_{i-1} are the diagonals of the quadrilateral with vertices $i - 2, i - 1, i, 3$. They satisfy the Ptolemy relation $f_{i-1} a_{i-1} = f_i \cdot 1 + f_{i-2} \cdot 1$. Since a_{i-1} is a 1-diagonal, we have $a_{i+1} \geq 2$. Then $f_i + f_{i-2} \geq 2f_{i-1}$. By the inductive hypothesis, we have $f_i + f_{i-1} > f_i + f_{i-2} \geq 2f_{i-1}$. Thus $f_i > f_{i-1}$.

From this we have $f_{n-2} > \dots > f_2 > f_1 > 1$, which means that $f_{n-2} > 1$. However f_{n-2} is the arc between vertices $n - 1$ and $n - 2$ i.e. a boundary arc. We get a contradiction because $f_{n-2} = 1$. Therefore we must have some 1-diagonal with weight less than or equal to 1. Since we are considering positive integral friezes, this means that some 1-diagonal has weight 1. \square

Theorem 4 Every frieze over $\mathbb{Z}_{>0}$ for an n -gon has a triangulation with all arcs weight 1.

Proof. We induct to show that every frieze for an n -gon has a triangulation with all arcs weight 1. The base case is $n = 4$ and the existence of a 1-diagonal with weight 1 is provided by Lemma 1. This arc gives a triangulation with all arcs weight 1 for a quadrilateral. For the

inductive step, suppose that every n -gon has a triangulation with all arcs weight 1. Given an $(n + 1)$ -gon, by the lemma it has a 1-diagonal of weight 1. If we consider the $(n + 1)$ -gon but without the part that the 1-diagonal cuts out, it is now an n -gon with all boundary sides weight 1. By the inductive hypothesis, this smaller n -gon has a triangulation with all arcs having weight 1. Then if we add the previously cut out part back in, we obtain a triangulation of the $(n + 1)$ -gon with all arcs having weight 1. \square

2.3 Friezes from dissections

2.3.1 Holm—Jørgensen friezes

There have been various generalizations of Conway and Coxeter’s result about non-negative integral friezes being in bijection with polygon triangulations. One approach is to generalize the notion of triangulation so that the set of arcs is no longer required to be maximal.

Definition A **dissection** of a marked surface (S, M) is a set of non-intersecting arcs.

Example The octagon on the left is triangulated whereas the one on the right is dissected. In a triangulation, all sub-gons are triangles whereas in a dissection we do not require this.

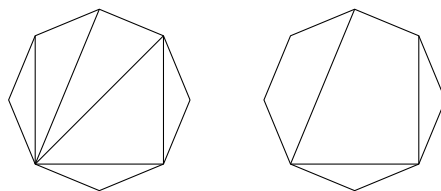

In 2017, Holm—Jørgensen introduce a map from dissections of an $(n + 3)$ -gon to frieze patterns of width n . This is Construction 0.3 in [9] and we briefly describe it.

Let a dissection of an n -gon P be given. For each vertex α of P , we assign the sum

$$\sum_{P_i \text{ is incident to } \alpha} \lambda_{p_i}$$

where the number $\lambda_p = 2 \cos(\frac{\pi}{p})$ is intended to reflect Euclidean lengths in regular p_i -gons. We repeat this sequence of numbers over and over and use it as the second-top row which we call the **quiddity row** of the frieze. This uniquely determines a frieze pattern through the diamond relation.

Definition A frieze pattern is of **type Λ_p** if the quiddity row consists of (necessarily positive) integral multiples of λ_p .

Example Consider the dissection of a hexagon below.

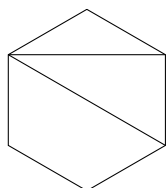

$$\lambda_3 = 1$$

$$\lambda_4 = \sqrt{2}$$

Since the sub-gons are triangles and quadrilaterals, the sums involve λ_3 and λ_4 . The dissection produces the following frieze pattern, which is not of type λ_6 because of the appearance of “mixed” numbers with nonzero coefficients for both the integer and $\sqrt{2}$ part.

$$\begin{array}{cccccccccc}
 0 & 0 & & 0 & & 0 & 0 & & 0 & \\
 & 1 & & 1 & & 1 & 1 & & 1 & \\
 1 & 2 & & 1 + \sqrt{2} & & \sqrt{2} & \sqrt{2} & & 2 + \sqrt{2} & \\
 \sqrt{2} & 1 & 1 + 2\sqrt{2} & & 1 + \sqrt{2} & 1 & 1 & 1 + 2\sqrt{2} & & \\
 & 1 & & 2 + \sqrt{2} & & 1 & 2 & & 1 + \sqrt{2} & \\
 0 & 0 & & 0 & & 0 & 0 & & 0 &
 \end{array}$$

Theorem 4.2 in [9] shows that this map is in fact injective, i.e.

$$\{\text{dissections of an } (n + 3)\text{-gon}\} \leftrightarrow \{\text{frieze patterns of width } n\}.$$

Moreover, if P was dissected into sub-polygons P_1, \dots, P_s where P_i is a p_i -gon, then the frieze from dissection takes values in \mathcal{O}_K , the ring of algebraic integers of the field $K = \mathbb{Q}(\lambda_{p_1}, \dots, \lambda_{p_s})$ where $\lambda_p = 2 \cos(\frac{\pi}{p})$. Then because of the bijection between frieze patterns and friezes on a polygon, this provides a way of generating friezes on a polygon.

We extract a useful result from Holm—Jørgensen 2017 for reference later:

Lemma 2 For any n -gon, an arc has weight 1 if and only if it is part of a dissection.

Remark The backward direction just comes from how we weight an arc in a dissection; the forward direction tells us that no arcs other than those from dissection have weight 1.

Holm—Jørgensen further sharpened their injection to a bijection in the case of dissections into sub-polygons of all the same size. They did this using some machinery about

Theorem 5 (Theorem A in [9]) Let $p \geq 3$ be an integer. There is a bijection between p -angulations of the $(n + 3)$ -gon and frieze patterns of type Λ_p and width n .

2.4 Tools to Compute Friezes

Now that we have defined friezes and frieze patterns, with some generalizations of these notions, we discuss some helpful tools that we used when working with these objects. We first describe a way to encode certain Ptomley relations as a determinants of a matrices and then define a new object called the universal snake graph that allows us to deal with several arcs on a surface at once.

2.4.1 Continuants

A continuant is the determinant of a particular matrix and allows us to compute the weight of any arc using the weights of certain 1-diagonals. Recall that 1-diagonals are arcs that skip one vertex of a polygon.

Proposition 1 ([4]) Consider an arc in a polygon with endpoints v_1 and v_n . Let a_i be the weight of the 1-diagonal that skips vertex v_i . Then the weight of the arc with endpoints v_1 and v_n is given by the determinant of the following matrix

$$\begin{bmatrix} a_1 & 1 & 0 & 0 & \cdots & 0 \\ 1 & a_2 & 1 & 0 & \cdots & 0 \\ 0 & 1 & a_3 & 1 & \cdots & 0 \\ \vdots & \ddots & \ddots & \ddots & \ddots & \vdots \\ 0 & \cdots & 0 & 1 & a_{n-1} & 1 \\ 0 & 0 & \cdots & 0 & 1 & a_n \end{bmatrix}$$

This result can also be found in Sophie Morier-Genoud’s beautiful survey [10].

Example Consider the pentagon below. Let w_i be the weight of the 1-diagonal that skips vertex i .

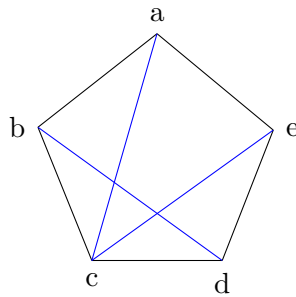

The weight of the boundary edge ae in the picture below is given by the determinant of the following 3×3 matrix

$$\begin{bmatrix} w_b & 1 & 0 \\ 1 & w_c & 1 \\ 0 & 1 & w_d \end{bmatrix}$$

2.4.2 Universal Snake Graphs

Universal snake graphs are a tool to calculate the weight of arcs in friezes coming from a dissection. Let D be a dissection of a polygon and let f denote the frieze it produces. Suppose we are interested in finding the weight of a particular arc in a polygon. We use the following algorithm:

1. Find a reference triangulation that includes the arc of interest.
2. Overlay the reference triangulation over the dissection D .
3. Find the shortest path from one end of the arc of interest to the other.
4. Count the number of vertices traversed and compute the weight of the arc of interest using Chebyshev polynomials and snake graphs.

For example, if the arc of interest in the reference triangulation is also an arc from dissection, we don't need to go past any vertex to get from one end of the arc to the other. Therefore the weight assigned to the arc is 1 by the properties of the **Chebyshev polynomials**, which will be defined below.

Definition Let $U_k(x)$ be defined by:

$$U_{-1}(x) = 0, U_0(x) = 1, U_k(x) = xU_{k-1}(x) - U_{k-2}(x)$$

these are **normalized Chebyshev polynomials of the second kind**. They are normalized as they can be obtained from the ordinary Chebyshev polynomials of the second kind by evaluating at $\frac{x}{2}$.

Lemma 3 Given a regular p -gon with sides of length 1, a k -diagonal has length $U_k(\lambda_p)$.

Corollary 1 Since a k -diagonal is the same thing as an $p - k - 2$ -diagonal in a p -gon, $U_k(\lambda_p) = U_{p-k-2}(\lambda_p)$. In particular, $U_{p-2}(\lambda_p) = U_0(\lambda_p) = 1$ and $U_{p-1}(\lambda_p) = U_0(\lambda_p) = 0$.

Lemma 4 Let \mathcal{F} be a frieze on a polygon which sends all boundary edges to 1 and all 1-diagonals to x . Then, \mathcal{F} sends all k -diagonals to $U_k(x)$.

Proof. We induct on k . For $k = 0$, a 0-diagonals are boundary edges which have length 1 by assumption. For $k = 1$, by assumption we have all 1-diagonals sent to $x = x \cdot 1 + 0 = xU_0(x) - U_{-1}(x) = U_1(x)$ indeed. Suppose that for all $m < k$ (where $k \geq 1$), the frieze \mathcal{F} sends all m -diagonals to $U_m(x)$. Consider a k -diagonal. We label the polygon $0, 1, 2, \dots$ in a cyclic clockwise way. Without loss of generality suppose that the k -diagonal is between vertices 0 and $k + 1$ (i.e. skipping the vertices $1, \dots, k$. If not just relabel the vertices). The vertices $0, 1, 2, k + 1$ form a quadrilateral with diagonals $\{0, 2\}$ and $\{1, k + 1\}$ and edges $\{0, 1\}, \{1, 2\}, \{2, k + 1\}, \{0, k + 1\}$. Note that the arc between vertices 1 and $k + 1$ is a $(k - 1)$ -diagonal whereas the arc between 2 and $k + 1$ is a $(k - 2)$ -diagonal. The frieze \mathcal{F} must satisfy the Ptolemy relation

$$\mathcal{F}(0, 2) \cdot \mathcal{F}(1, k + 1) = \mathcal{F}(0, 1) \cdot \mathcal{F}(2, k + 1) + \mathcal{F}(1, 2) \cdot \mathcal{F}(0, k + 1).$$

Now $\{0, 2\}$ is a 1-diagonal so $\mathcal{F}(0, 2) = x$. Thus

$$x \cdot U_{k-1}(x) = 1 \cdot U_{k-2}(x) + 1 \cdot \mathcal{F}(0, k + 1).$$

Rearranging we have

$$\mathcal{F}(0, k + 1) = xU_{k-1}(x) - U_{k-2}(x) = U_k(x)$$

by definition of the Chebyshev polynomial recurrence. Since $\{0, k + 1\}$ was an arbitrary k -diagonal (up to relabelling the vertices), we see that \mathcal{F} sends all k -diagonals to $U_k(x)$. \square

Theorem 6 Given a dissection \mathcal{D} of a polygon (into regular subgons) and an arc γ , weighted sum of matchings of the universal snake graph associated to γ gives the length of γ

Example We will use the universal snake graph to compute the frieze vector corresponding to the following dissection.

First we will pick a reference triangulation. Below is an example if a reference triangulation

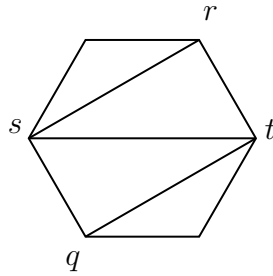

Then we will find the weight for each diagonal in the reference triangulation.

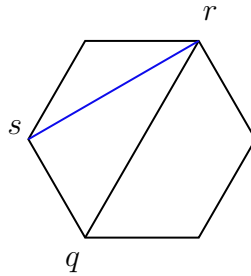

The weight of the arc sr in the figure above is $U_0 = 1$ by the properties of Chebyshev polynomials.

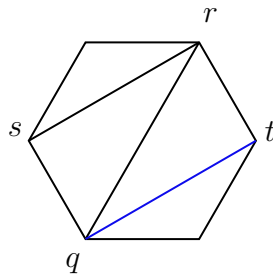

The weight of the arc qt in the picture above is $\sqrt{2}$ because every square and triangle in a dissection is regular, so the diagonal of a quadrilateral has weight $\sqrt{2}$.

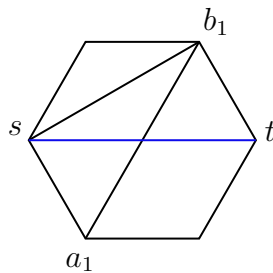

The weight of the arc st is $1 + \sqrt{2}$. Notice that st is in a quadrilateral in the dissection. Label the other two vertices of the quadrilateral with a_1 and b_1 . Then we get a labeled snake graph sb_1ta_1 . Find all perfect matchings of the snake graph. Multiply the weights of all the arcs in each perfect matching, and the sum of these products is the weight of st . In this particular case, $st = b_1s \cdot ta_1 + b_1t + sa_1 = 1 \cdot \sqrt{2} + 1 \cdot 1 = 1 + \sqrt{2}$.

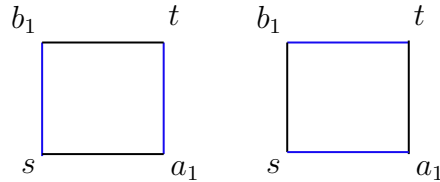

3 Explorations and Results

In this section, we discuss our main explorations with friezes and frieze patterns over the integral domain of focus i.e. $\mathbb{Z}[\sqrt{2}]$.

3.1 Friezes in $\mathbb{Z}[\sqrt{2}]$

We aim to study and classify friezes over $\mathbb{Z}[\lambda_{p_i}]_{p_i \in S}$ where $S \subseteq \mathbb{Z}_{\geq 3}$. Namely, we investigate when $S = \{3, 4\}$ so that the relevant ring is $\mathbb{Z}[\sqrt{2}]$. Here if a frieze came from a dissection, it would be into triangles and quadrilaterals.

There were two main questions that guided our study of friezes in $\mathbb{Z}[\sqrt{2}]$.

1. Holm—Jørgensen showed that there is an injection from dissections of a polygon to friezes on it. What is the image of this map for friezes over $\mathbb{Z}[\sqrt{2}]$?
2. Conway—Coxeter showed that every frieze over $\mathbb{Z}_{\geq 0}$ is unitary. How can we characterize unitary friezes over $\mathbb{Z}[\sqrt{2}]$?

We provide some background on $\mathbb{Z}[\sqrt{2}]$. It is a fact that $\mathbb{Z}[\sqrt{2}]$ is a Euclidean domain, and is therefore a unique factorization domain. An important tool in this domain is what we call the norm of elements in $\mathbb{Z}[\sqrt{2}]$.

Definition Let $a + b\sqrt{2} \in \mathbb{Z}[\sqrt{2}]$. We define a function $N : \mathbb{Z}[\sqrt{2}] \rightarrow \mathbb{N}$ such that $N(a + b\sqrt{2}) = |a^2 - 2b^2|$. We call N the **norm** of $\mathbb{Z}[\sqrt{2}]$.

Note that N is not a norm in the topological sense. It does not satisfy the triangle inequality in that there exist $w, z \in \mathbb{Z}[\sqrt{2}]$ such that $N(z+w) > N(z) + N(w)$. However N is multiplicative, meaning that for any $w, z \in \mathbb{Z}[\sqrt{2}]$, we have that $N(wz) = N(w)N(z)$. It is also a fact that the units in $\mathbb{Z}[\sqrt{2}]$ are exactly the elements of norm 1. One can show that these are of the form $\pm 1 \pm \sqrt{2}$.

3.1.1 Different types of friezes

We list four different types of friezes over $\mathbb{Z}[\sqrt{2}]$ that we are interested in studying.

Definition Given a dissection of an n -gon, we can produce a *frieze from dissection* using the method described in subsection 4.1. In these friezes, the arcs in the dissection have weight 1.

These are the friezes studied by Holm and Jørgensen in [9].

We have already defined unitary friezes, but we include it in this list for completeness and with an eye towards friezes in $\mathbb{Z}[\sqrt{2}]$.

Definition A frieze on a polygon is *unitary* if there exists a triangulation of the polygon such that the weight of each arc is a unit. For friezes over $\mathbb{Z}[\sqrt{2}]$, unit weights are of the form $(\pm 1 \pm \sqrt{2})^n$.

Definition We say that a frieze on a polygon is ≥ 1 if the weight of each arc is greater than or equal to 1.

We introduce these friezes because geometrically, it makes sense that the internal arcs of a polygon will be longer than the boundary arcs which we set to length 1.

Definition We say that a frieze on a polygon is a $\mathbb{Z}_{\geq 0}[\sqrt{2}]$ **frieze** if every arc's weight is of the form $a + b\sqrt{2}$ where $a, b \in \mathbb{Z}_{\geq 0}$.

3.1.2 Relationships between types of friezes

There are interesting relationships between the four types of friezes introduced previously.

Proposition 2 For friezes over $\mathbb{Z}[\sqrt{2}]$, we have the following containments:

1. $\{\text{friezes from dissections}\} \subseteq \{\mathbb{Z}_{\geq 0}[\sqrt{2}] \text{ friezes}\} \subsetneq \{\mathbb{Z}[\sqrt{2}]_{\geq 1} \text{ friezes}\}$
2. $\{\text{friezes from dissections}\}$ and $\{\text{unitary friezes}\}$ are incomparable.
3. $\{\text{unitary friezes}\}$ and $\{\mathbb{Z}_{\geq 0}[\sqrt{2}] \text{ friezes}\}$ are incomparable.
4. $\{\text{unitary friezes}\}$ and $\{\mathbb{Z}[\sqrt{2}]_{\geq 1} \text{ friezes}\}$ are incomparable.

Proof. We show each line of relations in turn.

1. The first containment, $\{\text{friezes from dissections}\} \subseteq \{\mathbb{Z}_{\geq 0}[\sqrt{2}] \text{ friezes}\}$, is a corollary of [1].

For the second containment, $\{\mathbb{Z}_{\geq 0}[\sqrt{2}] \text{ friezes}\} \subseteq \{\mathbb{Z}[\sqrt{2}]_{\geq 1} \text{ friezes}\}$, note that any number of the form $a + b\sqrt{2}$, where a and b are nonnegative integers with at least one non-zero will always be greater than or equal to 1.

To see that the first containment is strict, consider the following frieze pattern.

Example (Octagon with at least one set of zig-zag $1 + \sqrt{2}$ arcs)

0		0		0		0		0	
	1		1		1		1		1
$1 + \sqrt{2}$		$\sqrt{2}$		$1 + \sqrt{2}$		$\sqrt{2}$		$1 + \sqrt{2}$	
	$1 + \sqrt{2}$		$1 + \sqrt{2}$		$1 + \sqrt{2}$		$1 + \sqrt{2}$		$1 + \sqrt{2}$
2		$2 + \sqrt{2}$		2		$2 + \sqrt{2}$		2	
	$1 + \sqrt{2}$		$1 + \sqrt{2}$		$1 + \sqrt{2}$		$1 + \sqrt{2}$		$1 + \sqrt{2}$
$1 + \sqrt{2}$		$\sqrt{2}$		$1 + \sqrt{2}$		$\sqrt{2}$		$1 + \sqrt{2}$	
	1		1		1		1		1
0		0		0		0		0	

The frieze from this frieze pattern is in $\mathbf{Z}_{\geq 0}[\sqrt{2}]$. However, there is no dissection of a octagon that produces the frieze pattern. Note that the frieze corresponding to this frieze pattern is unitary.

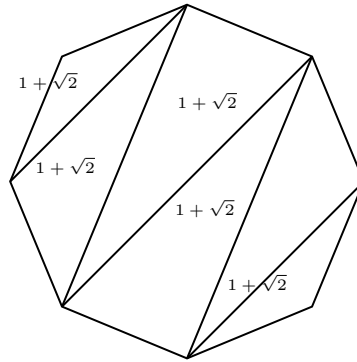

To see that the second containment is strict, consider the following frieze pattern.

Example (Hexagon with zig-zag $1 + \sqrt{2}$ arcs)

0		0		0		0		0	
	1		1		1		1		1
$1 + \sqrt{2}$		$\sqrt{2}$		$3 - \sqrt{2}$		$1 + \sqrt{2}$		$\sqrt{2}$	
	$1 + \sqrt{2}$		$-3 + 3\sqrt{2}$		$2\sqrt{2}$		$1 + \sqrt{2}$		$-3 + 3\sqrt{2}$
$1 + \sqrt{2}$		$\sqrt{2}$		$3 - \sqrt{2}$		$1 + \sqrt{2}$		$\sqrt{2}$	
	1		1		1		1		1
0		0		0		0		0	

This frieze contains an arc of weight $3 - \sqrt{2}$, so although all entries are greater than 1, this frieze is not a $\mathbf{Z}_{\geq 0}[\sqrt{2}]$ frieze.

2. To see that $\{\text{unitary friezes}\} \not\subset \{\text{friezes from dissections}\}$, we can again consider the previous example involving a hexagon with zig-zag $1 + \sqrt{2}$ arcs. It is a unitary frieze because it has the following unitary triangulation

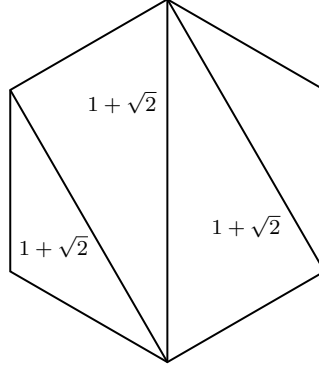

Yet looking at the frieze pattern, it does not have any arcs labeled 1. This means that if it were to come from dissection, it would be the empty dissection of a hexagon. However being the empty dissection of a hexagon causes the weight of some arc to have a multiple of λ_6 , which is not in $\mathbb{Z}[\sqrt{2}]$. Therefore, this is not a frieze from dissections.

To see that $\{\text{friezes from dissections}\} \not\subseteq \{\text{unitary friezes}\}$, consider the frieze coming from the empty dissection of a quadrilateral:

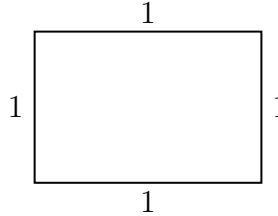

The diagonals of the quadrilateral both have weight $\sqrt{2}$ and so cannot participate in a unitary triangulation. Therefore, this is not a unitary frieze.

3. For contradiction, assume that $\{\mathbb{Z}_{\geq 0}[\sqrt{2}] \text{ friezes}\} \subseteq \{\text{unitary friezes}\}$. Then by (1) of this proposition, we would have $\{\text{friezes from dissections}\} \not\subseteq \{\text{unitary friezes}\}$. But this contradicts (2). Therefore, $\{\mathbb{Z}_{\geq 0}[\sqrt{2}] \text{ friezes}\} \not\subseteq \{\text{unitary friezes}\}$.

To see that $\{\text{unitary friezes}\} \not\subseteq \{\mathbb{Z}_{\geq 0}[\sqrt{2}] \text{ friezes}\}$, consider the frieze on a hexagon with zig-zag $1 + \sqrt{2}$ arcs. We saw that this frieze was unitary, but has an arc with weight $3 - \sqrt{2}$. This weight contains a negative coefficient and so the frieze is not a $\mathbb{Z}_{\geq 0}[\sqrt{2}]$ frieze.

4. Analogous to the proof of part (2), suppose for a contradiction that $\{\mathbb{Z}[\sqrt{2}]_{\geq 1} \text{ friezes}\} \subseteq \{\text{unitary friezes}\}$. Then by (1) of this proposition, we would have $\{\text{friezes from dissections}\} \subset \{\text{unitary friezes}\}$. But this contradicts (2). Therefore, $\{\mathbb{Z}[\sqrt{2}]_{\geq 1} \text{ friezes}\} \not\subseteq \{\text{unitary friezes}\}$.

Next, to see that $\{\text{unitary friezes}\} \not\subseteq \{\mathbb{Z}[\sqrt{2}]_{\geq 1} \text{ friezes}\}$, consider the following frieze on a quadrilateral with boundary edges having weight 1.

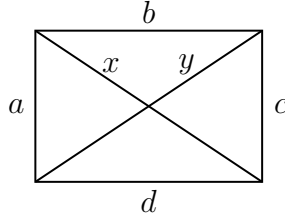

Let $x = (-1 + \sqrt{2})^2 = 3 - 2\sqrt{2}$ and $y = 2(1 + \sqrt{2})^2 = 6 + 4\sqrt{2}$. Then these weights satisfy the Ptolemy relation $xy = ac + bd = 2$. Note that $x = (-1 + \sqrt{2})^2$ is a unit in $\mathbb{Z}[\sqrt{2}]$ and the arc with weight x gives a triangulation of the quadrilateral. Therefore, this is a unitary frieze. However $x = (-1 + \sqrt{2})^2 = 3 - 2\sqrt{2} < 1$, so this is not a $\mathbb{Z}[\sqrt{2}]_{\geq 1}$ frieze. □

3.2 Investigating friezes coming from dissections

Holm—Jørgensen showed that there is an injective map from dissections of a polygon to friezes on the polygon [9]. We are interested in exploring the image of this map in the context of friezes on $\mathbb{Z}[\sqrt{2}]$. We initially conjectured that this image could be characterized by the size of the outputs of the frieze. This was based on geometric intuition. In a frieze from dissection, the arcs from the dissection have weight 1 and so by the Ptolemy relation all other arcs have weight greater than or equal to 1.

Lemma 5 All $w \in \mathbb{Z}[\sqrt{2}]$ with $N(w) = 2$ have the form $w = \sqrt{2}(\pm 1 + \sqrt{2})^n$.

Proof. Suppose that $w = a + b\sqrt{2}$ with $N(w) = |a^2 - 2b^2| = 2$. Then a^2 must be even, which implies that a must be even. Therefore, we have that $\sqrt{2}$ divides $a + b\sqrt{2}$. This is because $\frac{a+b\sqrt{2}}{\sqrt{2}} = \frac{a\sqrt{2}+2b}{2} = \frac{a}{2}\sqrt{2} + b$. This is an element of $\mathbb{Z}[\sqrt{2}]$ because a is even.

Thus we can express w as the product of $\sqrt{2}$ and $c + d\sqrt{2}$ for some $c, d \in \mathbb{Z}$. So we get $N(\sqrt{2})N(\frac{w}{\sqrt{2}}) = N(w) = \pm 2$, which implies that $2N(\frac{w}{\sqrt{2}}) = \pm 2$, so $N(\frac{w}{\sqrt{2}}) = \pm 1$. Then by the the fact that all units in $\mathbb{Z}[\sqrt{2}]$ have the form $\pm 1 \pm \sqrt{2}$, we get that $\frac{w}{\sqrt{2}} = (\pm 1 + \sqrt{2})^n$. Therefore $w = \sqrt{2}(1 + \sqrt{2})^n$ or $w = \sqrt{2}(-1 + \sqrt{2})^n$. □

Proposition 3 The set of $\mathbb{Z}[\sqrt{2}]_{\geq 1}$ friezes is equal to the set of friezes from dissection for a quadrilateral and a pentagon.

Proof. By Proposition 2, we already know that $\{\text{friezes from dissection}\} \subsetneq \{\mathbb{Z}[\sqrt{2}]_{\geq 1} \text{ friezes}\}$ in general. We show the opposite containment.

Suppose that we have a $\mathbb{Z}[\sqrt{2}]_{\geq 1}$ frieze on a quadrilateral. Let x and y denote the weights of the diagonals. By the Ptolemy relation, we must have $xy = 2$. Applying the norm to both sides and using the multiplicative property, we have $N(x)N(y) = N(2) = 4$. Since the

norm function outputs in the non-negative integers, we have either $N(x), N(y) = \pm 1, 4$, or $N(x) = N(y) = \pm 2$.

In the first case, without loss of generality suppose that $N(x) = \pm 1, N(y) = \pm 4$. Then x is a unit and has the form $x = (\pm 1 + \sqrt{2})^n$. Then correspondingly, we must have $y = 2(\pm 1 + \sqrt{2})^n$. However since $\mathcal{F}(\gamma) \geq 1$ for all arcs and $-1 + \sqrt{2} < \frac{1}{2}$, we must have $n = 0$. This gives us $x = 1, y = 2$. This is the frieze coming from the dissection of the quadrilateral into two triangles.

In the case where $N(x) = N(y) = 2$, we know from Lemma 5 that $x = \sqrt{2}(1 \pm \sqrt{2})^n, y = \sqrt{2}(\sqrt{2} \pm 1)^n$. Again we must have $n = 0$, which leads to $x = \sqrt{2}, y = \sqrt{2}$. This is the frieze coming from the empty dissection. \square

Below is progress toward showing that the set of $\mathbb{Z}[\sqrt{2}]_{\geq 1}$ friezes is equal to the set of friezes from dissection for a pentagon.

Consider a pentagon with vertices a, b, c, d, e . Let f_i be the weight assigned to the 1-diagonal skipping the vertex i , and let r_1, r_2 be the parameters of the 1-diagonals with $r_1, r_2 \in \mathbb{Z}[\sqrt{2}]$. Then by the Ptolemy relation, without loss of generality, we get the following relations between the weights of the 1-diagonals $f_a = \frac{r_2+1}{r_1}, f_b = \frac{r_1+r_2+1}{r_1r_2}, f_c = r_1, f_d = \frac{r_1+r_2+1}{r_2},$ and $f_e = r_2$. We can get more relations between the weights of the 1-diagonals by using the continuants. Again, let r_3, r_4 be the parameters of the 1-diagonals with $r_3, r_4 \in \mathbb{Z}[\sqrt{2}]$. The continuants give us the following relations: $f_a = \frac{r_3+1}{r_3r_4-1}, f_b = r_3r_4 - 1, f_c = \frac{r_4+1}{r_3r_4-1}, f_d = r_3, f_e = r_4$. We have an incomplete proof that the big conjecture works for the A_2 case. The proof is incomplete because it relies on the assumption that $r_3r_4 - 1$ is a unit. But we were unable to prove that $r_3r_4 - 1$ is a unit using the relations we have.

Conjecture [Not true in general!] The set of $\mathbb{Z}[\sqrt{2}]_{\geq 1}$ friezes is equal to the set of friezes from dissections.

Counter Example The set of $\mathbb{Z}[\sqrt{2}]_{\geq 1}$ friezes strictly contains the set of friezes from dissection for a hexagon.

Consider the example in the proof of Proposition 2 involving a hexagon with zig-zag $1 + \sqrt{2}$ arcs. It is unitary and ≥ 1 , but does not arise from a dissection. In particular, there are no arcs with weight 1 even though this is a frieze on a hexagon.

3.3 Number of dissections of a polygon into triangles and quadrilaterals

Proposition 4 Let $d(n)$ be the number of dissections of an n -gon into triangles and quadrilaterals. We have the recursive formula

$$d(n) = \sum_{k=2}^{n-1} d(k) \cdot d(n-k+1) + \sum_{\ell=1}^{n-2} \sum_{m=\ell+1}^{n-1} d(\ell) \cdot d(m-\ell+1) \cdot d(n-m+1).$$

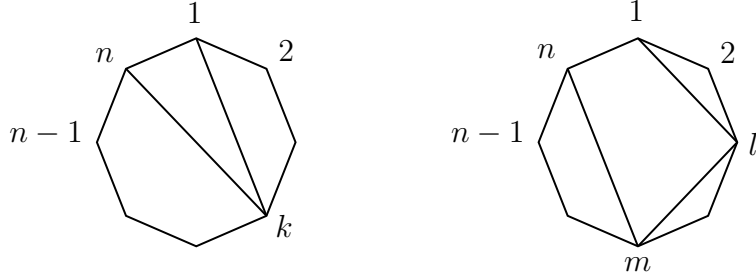

Figure 1: The picture on the left is the first case, where the edge between 1 and n is in a triangle. The picture on the right is the second case, where the edge between 1 and n is in a quadrilateral.

Proof. Let P be an n -gon. We label the vertices $1, 2, \dots, n$ in a cyclic ordering, as indicated in the picture above.

Consider the edge between vertices 1 and n . Observe that there are two cases. Either the edge is a part of a triangle or it is a part of a quadrilateral.

We first consider the case where the edge between vertices 1 and n is part of a triangle. Let k be the third vertex of the triangle. Then we have $k \in [2, n - 1]$. This means that the n -gon is divided into at most three sub-polygons, a k -gon, a triangle, and a $(n - k + 1)$ -gon. From this case, we get $\sum_{k=2}^{n-1} d(k) \cdot d(n - k + 1)$ ways to dissect an n -gon into triangles and quadrilaterals.

Next we consider the case where the edge between vertices 1 and n is part of a quadrilateral. Let m and ℓ be the other two vertices of the quadrilateral. Then the n -gon is divided into at most four sub-polygons, an ℓ -gon, a quadrilateral, an $(m - \ell + 1)$ -gon, and a $(n - m + 1)$ -gon. From this case, we get $\sum_{\ell=1}^{n-2} \sum_{m=\ell+1}^{n-1} d(\ell) \cdot d(m - \ell + 1) \cdot d(n - m + 1)$ ways to dissect an n -gon into triangles and quadrilaterals.

Combining the two cases, we obtain the recursive formula

$$d(n) = \sum_{k=2}^{n-1} d(k) \cdot d(n - k + 1) + \sum_{\ell=1}^{n-2} \sum_{m=\ell+1}^{n-1} d(\ell) \cdot d(m - \ell + 1) \cdot d(n - m + 1)$$

for the total number of dissections of the n -gon into triangles and quadrilaterals. □

We wrote a Sage function to generate all possible dissections into triangles and quadrilaterals of a polygon. Note that we assume that all the vertices of a polygon are labeled. Therefore two dissections could be the same up to symmetry. The code is in the Appendix. Based on the "produce_dissection" function, the Sage function "b_square" produces the generating function for the number of squares in the dissections into triangles and squares of any given n -gon. The generating function is defined as follows:

$$a_n(t) = \sum_{\text{dissections of an } n\text{-gon into triangles and squares}} t^{\text{number squares}}$$

We computed the generating functions for $n = 3, 4, 5, 6, 7$ using the Sage function.

$$\begin{aligned}
a_3(t) &= 1 \\
a_4(t) &= 2 + t \\
a_5(t) &= 5 + 5t \\
a_6(t) &= 3 + 21t + 14t^2 \\
a_7(t) &= 28 + 84t + 42t^2
\end{aligned}$$

It is well-known that $a_n(-1)$ gives us the Euler characteristics of the cubical complex of an n -gon.

The function "a_square" is as follows:

```

def b_square(n):
    dissections = produce_dissection(n)
    dis_list = []
    tot_list = []
    for i in produce_dissection(n):
        num_sq = n-3-len(i)
        tot_list.append(num_sq)
        if dis_list.count(num_sq) == 0:
            dis_list.append(num_sq)
    dis_list.sort()
    a_n_poly = 0
    t = var('t')
    for j in range(len(dis_list)):
        coef = tot_list.count(j)
        a_n_poly += coef * t^j
    return a_n_poly

```

3.4 Computational tool for friezes from dissection

The procedure of making a dissection of a polygon into a frieze on a polygon (described in 2.3) becomes lengthy as the size of the polygon increases. As such, we wrote Sage code to facilitate the process and allow us to compute examples and test conjectures more efficiently.

The function "frieze maker" generates the frieze pattern from a dissection of an n -gon given the quiddity row. The function "unitary arc spotter" identifies which arcs are unit length by checking for entries of the frieze with norm equal to 1. Finally the function "unitary triangulation decider" runs through all possible cardinality $n - 3$ subsets of those unitary arcs and checks whether or not they cross. If they are pairwise non-crossing, then we have a maximal set of unitary arcs and thus a unitary triangulation. In this case, the function decides that the frieze is unitary and outputs all possible unitary triangulations. Otherwise, the function outputs "Not unitary because not enough unitary arcs" (in the case where there are no cardinality $n - 3$ subsets of unitary arcs) or "Not unitary because the unitary arcs cross too much."

Example Consider the following dissection of an octagon.

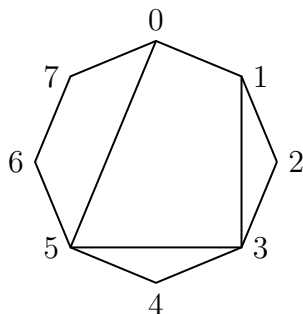

We input the quiddity row $(2\sqrt{2}, 1 + \sqrt{2}, 1, 2 + \sqrt{2}, 1, 1 + 2\sqrt{2}, \sqrt{2}, \sqrt{2})$ into the code. The code outputs that the frieze coming from this dissection is unitary, with a single unitary triangulation given by the set of arcs $\{\{0, 3\}, \{1, 3\}, \{3, 6\}, \{3, 7\}, \{4, 6\}\}$.

3.5 Unitary Friezes that Come From Dissections

In the proof for statement 1 of Proposition 2, the two friezes used to show strict containments are both unitary despite the fact that neither comes from a dissection. This makes us wonder what characterizes the intersection of unitary friezes and friezes from dissection.

3.5.1 Simplified Pictures of Dissections

To better distinguish distinct dissections of polygons, we draw simplified pictures of dissections. Instead of keeping the rigid equilateral frame of a regular polygon, we deform a convex regular polygon into a gluing of similarly-shaped triangles and quadrilaterals while still preserving edge and vertex adjacencies.

Example The two pictures below depict the same dissection of an octagon. The one on the left keeps the rigid equilateral frame of a regular octagon whereas the one on the right is the simplified picture.

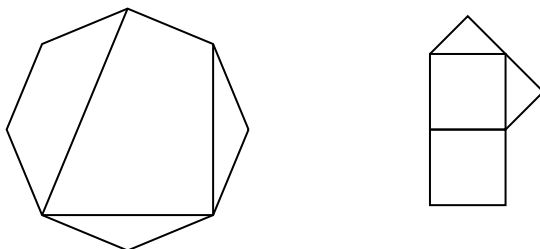

Note that not every simplified picture consisting of a gluing of subpolygons corresponds to a dissection of a polygon. In particular, when a vertex is "internal" because it is surrounded by sub-polygons, the simplified picture does not come from a dissection.

For example, the simplified picture on the left does not come from a dissection, while the one on the right does.

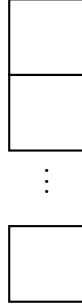
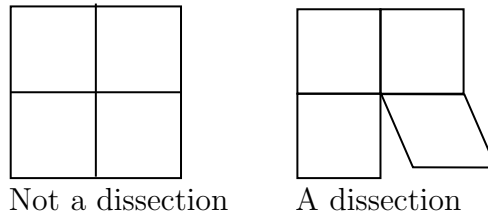

Figure 2: a stack



In the rest of the paper, we will use simplified pictures to represent dissections of polygons.

3.5.2 Families of Unitary and Non-Unitary Friezes

We will identify a few families of dissections that give rise to unitary and non-unitary friezes. The first family is a **stack**.

Definition A **stack of height n** where $n \geq 1$ is a dissection of $(2n+2)$ -gon whose simplified diagram consists of n quadrilaterals arranged in a straight line.

Definition Let \mathbf{d}_n denote the weight of an arc in a stack that starts and ends on opposite sides of the stack and traverses n -many arcs in the dissection.

Let \mathbf{s}_n denote the weight of an arc in a stack that starts and ends on the same side of the stack and traverses n -many arcs in the dissection.

The quantities \mathbf{d}_n and \mathbf{s}_n are well-defined because a stack is uniformly made of quadrilaterals with no distinguishing features. Thus the weight of such arcs is solely determined by how many arcs in the dissection are crossed and whether the start and end points are on the same side.

Example The dashed arc on the left would be denoted d_2 whereas the dashed arc on the right would be denoted s_3 .

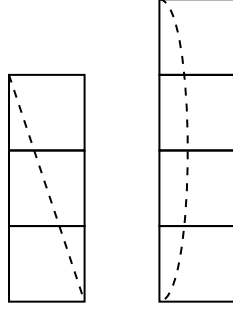

We get the following recursive formulas for d_i and s_i :

Lemma 6 Given a stack of height n with $n \geq 1$, for any $0 < i \leq n - 1$,

$$d_i = d_{i-1}\sqrt{2} + s_{i-1}$$

$$s_i = s_{i-1}\sqrt{2} + d_{i-1}.$$

Proof. We can find the recursive formulas for d_i and s_i using the Ptolemy relation. The picture on the left depicts the quadrilateral we use for finding d_i while the one on the right is for s_i . By the Ptolemy relation, we get

$$d_i = d_{i-1}d_0 + s_{i-1}s_0$$

$$s_i = s_{i-1}d_0 + d_{i-1}s_0.$$

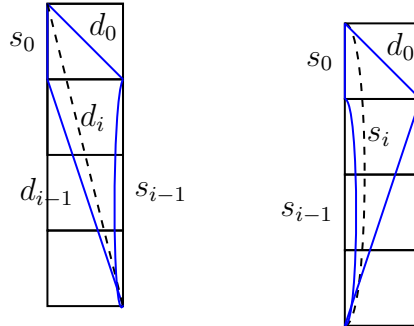

Since d_0 is the diagonal of a square and s_0 is the boundary arc of a square, we know that $d_0 = \sqrt{2}$ and $s_0 = 1$. Therefore

$$d_i = d_{i-1}d_0 + s_{i-1}s_0 = d_{i-1}\sqrt{2} + s_{i-1}$$

$$s_i = s_{i-1}d_0 + d_{i-1}s_0 = s_{i-1}\sqrt{2} + d_{i-1}.$$

□

We tabulate the first few values of d_i and s_i and notice that given any $0 \leq i \leq n - 1$, either d_i is a multiple of $\sqrt{2}$ and s_i is an integer, or d_i is an integer and s_i is a multiple of $\sqrt{2}$.

i	0	1	2	3	4	...
d_i	$\sqrt{2}$	3	$5\sqrt{2}$	17	$29\sqrt{2}$...
s_i	1	$2\sqrt{2}$	7	$12\sqrt{2}$	41	...

We will show the observation holds in general in the following corollary

Corollary 2 Given any $0 \leq i \leq n - 1$, either d_i is a multiple of $\sqrt{2}$ and s_i is an integer, or d_i is an integer and s_i is a multiple of $\sqrt{2}$.

Proof. We will use induction for the proof. We know that $d_0 = \sqrt{2}$ and $s_0 = 1$, so the base case is done. For the induction step, consider $i = k$ with $0 < k < n - 1$. We have two cases: either d_k is a multiple of $\sqrt{2}$ and s_k is an integer, or d_k is an integer and s_k is a multiple of $\sqrt{2}$. In the first case, d_k is a multiple of $\sqrt{2}$ and s_k is an integer. Then by Lemma 6, $d_{k+1} = d_k\sqrt{2} + s_k$ is an integer and $s_{k+1} = s_k\sqrt{2} + d_k$ is a multiple of $\sqrt{2}$. In the second case, d_k is an integer and s_k is a multiple of $\sqrt{2}$. Then, by similar reasoning, $d_{k+1} = d_k\sqrt{2} + s_k$ is a multiple of $\sqrt{2}$ and $s_{k+1} = s_k\sqrt{2} + d_k$ is an integer.

In particular, d_i is a multiple of $\sqrt{2}$ and s_i is an integer for $i \equiv 0, 2 \pmod{3}$ while d_i is an integer and s_i is a multiple of $\sqrt{2}$ for $i \equiv 1 \pmod{3}$. □

Corollary 3 For any $(2n + 2)$ -gon, only boundary arcs and the arcs from dissection have unit weights.

Proof. In a $(2n + 2)$ -gon, if an arc is neither a boundary arc nor an arc from dissection, then it can be expressed as either d_i with $0 \leq i \leq n - 1$ or s_i with $0 < i \leq n - 1$. Since each of the d_i 's and s_i 's is either an integer or a multiple of $\sqrt{2}$ by Corollary 2, all of them have non-unit weights. We know that all boundary arcs and the arcs from dissection have weight 1. Therefore, only boundary arcs and the arcs from dissection have unit weights. □

Proposition 5 $(2n + 2)$ -gons (where $n \geq 1$) always have a dissection leading to a non-unitary frieze. This is provided by the family of dissections into a stack of height n .

Proof. Every $(2n + 2)$ -gon can be dissected into a stack of height n . It is sufficient to show that the family of dissections into a stack of height n is not unitary. This result could be shown by leveraging Theorem A in [9], however we show it directly in order to introduce useful notation.

Note that in a stack, all non-boundary arcs that are not from dissection are either d_i for for some $0 \leq i \leq n - 1$ or s_i for $0 < i \leq n - 1$. The inequalities come from how 0 and $n - 1$ are respectively the minimum and maximum number of arcs from dissection that could be crossed, and we exclude s_0 because it is a boundary arc. Arcs from dissection have weight 1 which is a unit, but a $(2n + 2)$ -gon requires $2n - 1$ non-boundary arcs to be triangulated whereas there are only $n - 1$ arcs from dissection. Therefore for a triangulation we would need to fill up the lack by arcs that are neither boundary arcs nor the arcs from dissection. By Corollary 3, we know that only boundary arcs and the arcs from dissection have unit weights, so a unitary triangulation is impossible. Therefore, the family of dissections into a stack of height n is not unitary. □

Definition A **tower** is a dissection of a $(2n + 3)$ -gon whose simplified diagram consists of a stack of height $n \geq 0$ with a triangle on top. When $n = 0$, the tower is just a triangle.

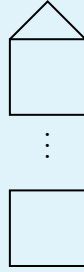

Definition We define the triangle of a tower a **roof**.

Lemma 7 Let ℓ_m denote an arc from the top vertex of roof to a vertex in the stack that crosses $m > 0$ horizontal arcs in the dissection. Then

$$\ell_m = d_{m-1} + s_{m-1} = (1 + \sqrt{2})^m.$$

Proof. Note that the tower is symmetric so it doesn't matter whether the vertex is on the left or right. Situate ℓ_m as a diagonal in a quadrilateral whose edges are the two sides of the roof not adjacent to any quadrilateral, the diagonal with weight d_{m-1} , and the diagonal with weight s_{m-1} . Note that the other diagonal of this quadrilateral is the bottom arc of the triangle which has weight 1. Thus by the Ptolemy relation we have $\ell_m = d_{m-1} + s_{m-1}$.

Further, we will show that $\ell_m = d_{m-1} + s_{m-1} = (1 + \sqrt{2})^m$. We show this by induction on m . For the base case where $m = 1$, we have $\ell_1 = d_0 + s_0 = \sqrt{2} + 1 = (\sqrt{2} + 1)^1$. Suppose the claim is true for $m < k$. We use the recurrences from Lemma 6 where

$$d_{k-1} = d_{k-2}\sqrt{2} + s_{k-2}$$

$$s_{k-1} = s_{k-2}\sqrt{2} + d_{k-2}.$$

Then adding the above recurrences and using the inductive hypothesis we have

$$\begin{aligned} \ell_k &= \sqrt{2}(d_{k-2} + s_{k-2}) + (d_{k-2} + s_{k-2}) = (1 + \sqrt{2})(1 + \sqrt{2})^{k-1} \\ &= (1 + \sqrt{2})^k. \end{aligned}$$

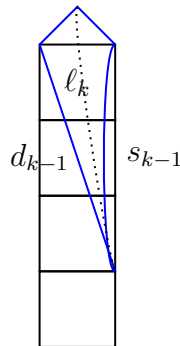

□

Proposition 6 A tower with a stack of height $n \geq 0$ gives unitary friezes on a $(2n + 3)$ -gon.

Proof. Let T_n denote the tower with $n \geq 0$ squares under the triangle. From Corollary 3, we know that all the arcs between vertices in the stack portion of the tower are not units. There are $2n$ non-boundary arcs from the top vertex of the roof to vertices in the stack. By Lemma 7, we know that all $2n$ arcs have unit weights, and we know that they don't intersect each other. Since triangulation is maximal, these arcs form a unitary triangulation of T_n .

Thus all the arcs ℓ_m from the roof of the tower to vertices of the stacked boxes have unit length. Together they constitute a unitary triangulation of the $(2n + 3)$ -gon. \square

We extract for later use the result about arcs ℓ_m being of unit weight.

Lemma 8 Arcs going from the top vertex of roof of a tower to a vertex in the stack of boxes and crossing $m > 0$ horizontal arcs in the dissection have unit weight $\ell_m = (1 + \sqrt{2})^m$.

Note that all the unit arcs used in this result come from the top vertex of the roof. We give these a name for convenience.

Definition A **tower arc** is a non-boundary arc in a tower going from the top vertex of the roof to a vertex contained in the tower's stack. As shown in the proof of Proposition 6, these have unit weight.

Given a tower with a stack of height n , if $n = 0$, there is no tower arc. If $n > 0$, all the non-boundary arcs not from dissection are tower arcs as indicated in the figure below.

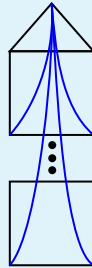

Proposition 7 Any dissection into any arrangement of boxes will give a non-unitary frieze.

Proof. By Theorem A of [9], there is a bijection between dissections into quadrilaterals of the $(n + 3)$ -gon and frieze patterns of type Λ_4 and width n . This means that the quiddity row of the frieze pattern coming from such a dissection will have all entries being a multiple of $\sqrt{2}$. By the diamond relation, since the row above the quiddity row is all integers (specifically all 1's), the row below the quiddity row will be all integers. This forces the third non-trivial row to have all entries being integer multiples of $\sqrt{2}$. For example, the entry directly below $\ell\sqrt{2}$ in the third non-trivial row is $\sqrt{2}(2\ell m k - k - m)$. Let k, ℓ, m be integers. The frieze pattern takes the following form.

$$\begin{array}{ccccccc}
 0 & & 0 & & 0 & & \dots \\
 & 1 & & 1 & & 1 & \dots \\
 k\sqrt{2} & & \ell\sqrt{2} & & m\sqrt{2} & & \dots \\
 & 2k\ell - 1 & & 2m\ell - 1 & & \dots & \\
 & & & \vdots & & & \\
 & & & & & &
 \end{array}$$

The rows of the frieze pattern continue to alternate in this way until we reach the bottom trivial rows of 1's. Indeed, consider the $(k + 1)$ st non-trivial row with $k \in (1, \dots, n)$. By strong induction, for all $i \in (1, \dots, k)$, the entries of the i th non-trivial row are either all integers or all integer multiples of $\sqrt{2}$ and the pattern alternates between rows. Without loss of generality, assume all the entries of the k th non-trivial row are integers. Then by the induction assumption, all the entries in the $(k - 1)$ st row are integer multiples of $\sqrt{2}$. Let x be an entry in the $(k + 1)$ st non-trivial row. Then by the diamond relation, x is equal to the product of two integers divided by an integer multiple of $\sqrt{2}$. Since all the entries of the frieze pattern are in the ring $\mathbb{Z}[\sqrt{2}]$, it must be the case that x is an integer multiple of $\sqrt{2}$. Therefore, all the entries of the frieze pattern are either integer multiples of $\sqrt{2}$ or integers, among which, only 1 is a unit.

By construction, we know that the only non-boundary arcs with weight 1 are the arcs from dissection. In a dissection into any arrangement of n boxes, there will be $n - 1$ arcs from dissection but the overall polygon would be a $(2n + 2)$ -gon which needs $(2n - 1)$ arcs for a triangulation. There are not enough arcs with unit weights for a unitary triangulation. Hence dissections into such arrangements give rise to non-unitary friezes. □

3.5.3 Statement of the Main Conjecture in $\mathbb{Z}\sqrt{2}$

From the data generated by our Sage functions on all the dissections of a heptagon and an octagon, we observe that all the unitary triangulations in these examples only contain tower arcs. Thus we want to show the next conjecture

Conjecture A frieze from a dissection in $\mathbb{Z}\sqrt{2}$ is unitary if and only if the dissection is a gluing of towers.

The forward direction, if a dissection is a gluing of towers, is straightforward to show. Indeed, if a dissection can be decomposed into towers, the tower arcs give a unitary triangulation by Lemma 8. The backward direction, if a frieze from dissection is unitary, then it is a gluing of towers, is more difficult to show. We want to prove it by its contrapositive, if a dissection is not a gluing of towers, then the frieze from the dissection is not unitary. The strategy is to show that if a dissection is not a gluing of towers, then there must exist at least one arc with a non-unit weight in every triangulation.

3.5.4 Puzzle Pieces

First we will use the results on stacks and towers to introduce a series of arcs that cross a small number of triangles, which we call "puzzle pieces." With the Ptolemy relation, we can determine that these arcs have non-unit weights by brute-force. We will use these "puzzle pieces" in Theorem 7 to show that longer arcs also cannot appear in a unitary triangulation. Thereby, we will prove that a dissection indecomposable into towers does not produce a unitary frieze.

Lemma 9 In a tower, the weight of the arc from the top vertex of the roof to any vertex in the stack adjacent to the stack of the tower is not a unit.

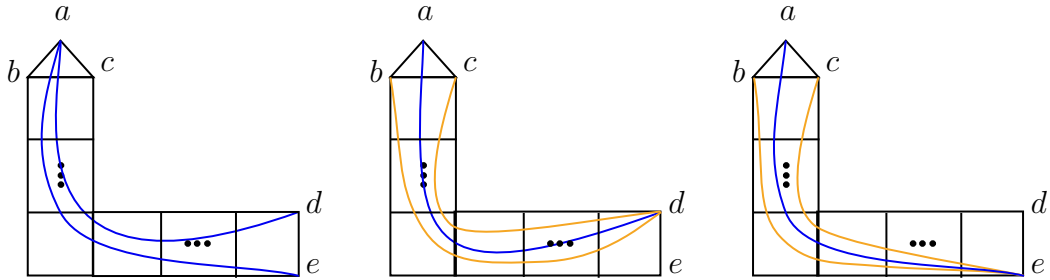

Figure 3: We use the quadrilateral $abdc$ to obtain the weight of ad and the quadrilateral $abec$ to obtain the weight of ae .

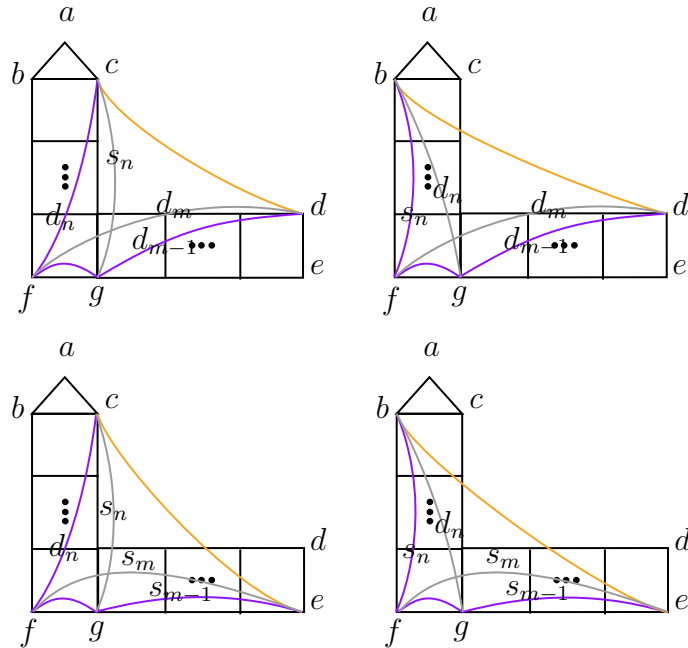

Figure 4: We use the quadrilaterals $cfgd$, $bfgd$, $cfge$ and $bfge$ to obtain the weights of cd , bd , ce and be respectively.

Proof. Assume there are $n + 1$ squares between g and c and m squares between g and e . We will show that the weights of the arcs ad and ae are not units. Let w_{ij} be the weight assigned to the arc ij . We will find the weights of the arcs bd, cd, be and ce using the quadrilaterals $bfgd, cdgf, bfge$, and $fceg$ respectively. Then by the Ptolemy relation we have the following equations:

$$\begin{aligned}w_{bd} &= d_m d_n - s_n d_{m-1} \\w_{cd} &= s_n d_m - d_n d_{m-1} \\w_{ce} &= s_n s_m - s_{m-1} d_n \\w_{be} &= d_n s_m - s_n s_{m-1}\end{aligned}$$

Therefore by the Ptolemy relation,

$$w_{ae} = d_n s_m - s_n s_{m-1} + s_n s_m - s_{m-1} d_n = (s_m - s_{m-1})(s_n + d_n)$$

and

$$w_{ad} = d_m d_n - s_n d_{m-1} + s_n d_m - d_n d_{m-1} = (d_m - d_{m-1})(d_n + s_n).$$

We know that $s_n + d_n$ is a unit since $s_n + d_n = (1 + \sqrt{2})^{n+1}$. Let $(1 + \sqrt{2})^k = a + b\sqrt{2}$ and $(-1 + \sqrt{2})^k = c + d\sqrt{2}$ for some $a, b, c, d \neq 0$. Then $|a| = |c|$ and $|b| = |d|$ by the properties of binomial coefficients. We will show that neither $s_m - s_{m-1}$ nor $d_m - d_{m-1}$ is a unit.

First consider $s_m - s_{m-1}$. By Corollary 2, we know that s_m is either an integer or an integer multiple of $\sqrt{2}$. Then by Lemma 6 and Corollary 2, we know that if s_m is an integer, d_m is an integer multiple of $\sqrt{2}$ and d_{m-1} an integer, which implies that s_{m-1} is an integer multiple of $\sqrt{2}$; if s_m is an integer multiple of $\sqrt{2}$, d_m is an integer and d_{m-1} a multiple of $\sqrt{2}$, which implies that s_{m-1} is an integer. Therefore, only one of s_m and s_{m-1} is an integer and the other is an integer multiple of $\sqrt{2}$.

So we can express $s_m - s_{m-1}$ as $x + y\sqrt{2}$ with $x, y \in \mathbb{Z}$. Since we are in the ring $\mathbb{Z}[\sqrt{2}]_{\geq 1}$ and s_m and s_{m-1} are both arc weights, s_m and s_{m-1} are both positive. By Lemma 8, we know that $s_m + d_m = \ell_m = (1 + \sqrt{2})^m$ is a unit. Then it is impossible that $s_m - s_{m-1} = (1 - \sqrt{2})^m$. We will prove this by contradiction. Assume $s_m - s_{m-1} = (1 - \sqrt{2})^m$. Let $s_m + d_{m-1} = a_m + b_m\sqrt{2}$ and $s_m - s_{m-1} = c_m + d_m\sqrt{2}$. Then we have shown that $|a_m| = |c_m|$ and $|b_m| = |d_m|$. This implies that $|s_{m-1}| = |d_m|$. Since s_{m-1} and d_m are both positive, we get $s_{m-1} = d_m$. But by Lemma 6, $d_m = d_{m-1}\sqrt{2} + s_{m-1}$ and $d_{m-1} \geq 1$, so $d_m > s_{m-1}$. So $d_m \neq s_{m-1}$, a contradiction. Thus $s_m - s_{m-1}$ is not a unit. Similarly, $d_m - d_{m-1}$ is not a unit because $s_m \neq d_{m-1}$. Therefore since w_{ad} and w_{ae} are both products of a unit and a non-unit, w_{ad} and w_{ae} are not units. \square

Lemma 10 An arc starting and ending at a triangle with only a stack in between has non-unitary weight.

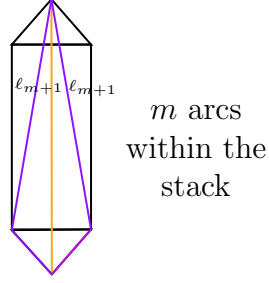

Proof. Doing a Ptolemy relation on the purple quadrilateral pictured above, we obtain the weight of the orange arc to be $1 \cdot \ell_{m+1} + 1 \cdot \ell_{m+1} = 2\ell_{m+1}$ by Lemma 8. This quantity has norm 2 and thus cannot be a unit. \square

Lemma 11 An arc starting from a stack and ending in a different stack and passing through a single triangle has non-unit weight.

Proof. We consider the four possible configurations in the picture below separately.

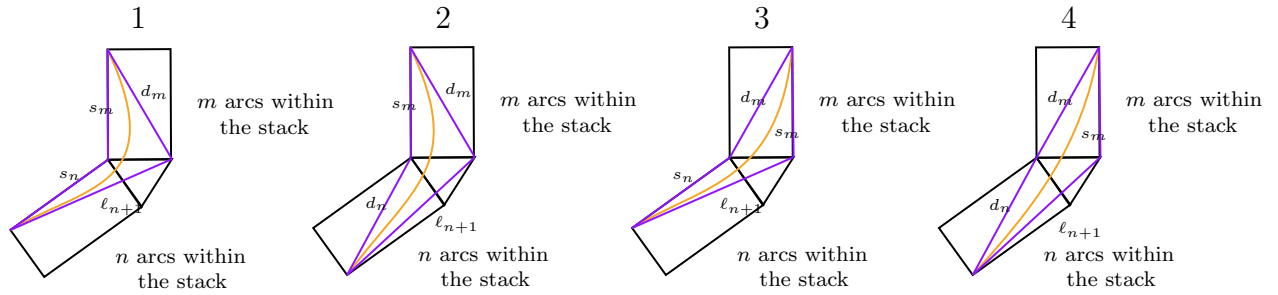

We obtain an expression for the weight of the arc by applying the Ptolemy relation in the respective purple quadrilaterals, as shown in the configurations above.

Configuration number	Expression for weight of arc
1	$d_m s_n + \ell_{n+1} s_m$
2	$d_m d_n + \ell_{n+1} s_m$
3	$s_m s_n + \ell_{n+1} d_m$
4	$s_m d_n + \ell_{n+1} d_m$

We claim that the weight for the first configuration $d_m s_n + \ell_{n+1} s_m$ must be non-unitary. This is because

$$\begin{aligned}
 d_m s_n + \ell_{n+1} s_m &= \ell_{n+1}(s_m + d_m) - d_m \ell_{n+1} + d_m s_n \\
 &= \ell_{n+1}(s_m + d_m) - d_m(\ell_{n+1} - s_n) \\
 &= \ell_{n+1} \ell_{m+1} - d_m d_n.
 \end{aligned}$$

Note that by Corollary 2, $d_m d_n$ is either an integer or a multiple of $\sqrt{2}$. However, either way, subtracting $d_m d_n$ from $\ell_{n+1} \ell_{m+1}$ lower either the integer or the multiple of $\sqrt{2}$ part of the unit $\ell_{n+1} \ell_{m+1}$, but the subtraction does not alter the other component. And we know that $\ell_{n+1} \ell_{m+1}$ is a power of $(1 + \sqrt{2})$ by Lemma 7. Therefore, $\ell_{n+1} \ell_{m+1} - d_m d_n$ cannot be a power of $(1 + \sqrt{2})$. Meanwhile, since $d_m s_n + \ell_{n+1} s_m$ is a sum of two products that are both greater than or equal to 1 and any power of $(\sqrt{2} - 1)$ is strictly less than 1, $\ell_{n+1} \ell_{m+1} - d_m d_n$ also

can't be a power of $(\sqrt{2}-1)$. Therefore, $d_m s_n + \ell_{n+1} s_m$ is not a unit. Similar arguments show that the weights of the arcs in the other configurations are not units. \square

Lemma 12 An arc starting at a triangle and ending at a square, passing through exactly two towers has a non-unit weight.

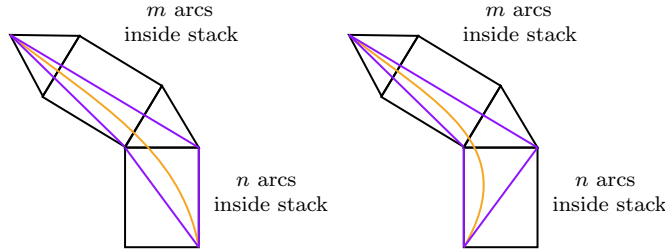

Proof. There are two possible configurations of such arcs. For the configuration on the left, applying the Ptolemy relation on the purple quadrilateral gives the weight of the desired orange arc as

$$\ell_{m+1} s_n + 2\ell_{m+1} d_n = \ell_{m+1}(s_n + 2d_n) = \ell_{m+1}(\ell_{n+1} + d_n)$$

using the fact that $s_n + d_n = \ell_{n+1}$ by Lemma 7 and the fact that the arc passing through a stack of height m with a triangle on both sides has weight $2\ell_{m+1}$ by Lemma 10. Recall that d_n is either an integer or a multiple of $\sqrt{2}$. Thus adding it to ℓ_{n+1} only increases either the integer or the coefficient of $\sqrt{2}$ component of ℓ_{n+1} , while the other component stays the same.

Note that if $a + b\sqrt{2}$ is a unit, then the “conjugates” $\pm a \pm b\sqrt{2}$ are units. Moreover only specific pairs (a, b) give rise to units in $\mathbb{Z}[\sqrt{2}]$. Since $\ell_{n+1} \in \mathbb{Z}_{\geq 0}[\sqrt{2}]$ (by Proposition 2 part 1 because it is an arc in a frieze coming from dissection), it is not possible to get a unit by increasing either the integer or the coefficient of $\sqrt{2}$ component of ℓ_{n+1} . Thus the sum $\ell_{n+1} + d_n$ is not a unit. We know that ℓ_{m+1} is a unit by Lemma 7. Since the product of a unit and a non-unit is not a unit, the weight of the orange arc, $\ell_{m+1}(\ell_{n+1} + d_n)$, is not a unit.

We similarly obtain the expression $\ell_{m+1}(\ell_{n+1} + s_n)$ for the weight of the orange arc in the configuration on the right. Likewise it is not a unit. \square

3.5.5 An Inductive Proof Attempt and More Puzzle Pieces

Now we have introduced all the “puzzle pieces,” we are moving away from direct computations and towards showing that the existence of certain arcs in a unitary triangulation will force the non-unit arcs in the “puzzle pieces” to appear in the unitary triangulation. Thereby, by contradiction, these arcs cannot exist in any unitary triangulation. With this approach, we hope to show that the only arcs that can appear in a unitary triangulation are tower arcs.

Definition We define a k -arc by counting the number of triangles traversed by the arc. In particular, a triangle at the start or the end of the arc adds $\frac{1}{2}$ to the total number, while a triangle in the middle adds 1. An arc is a k -arc if and only if it passes through k triangles.

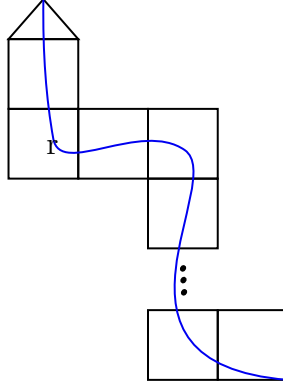

Figure 5: r is a $\frac{1}{2}$ -arc, so r passes through a triangle at the start of the arc and only squares along the rest of the arc.

Proposition 8 If a 0-arc does not come from a dissection, then its weight is not a unit.

Proof. A 0-arc is an arc that does not pass through any triangles. Then a 0-arc is either an arc from dissection, which always has weight 1, or an arc that only passes through squares, which, by Proposition 7, has a non-unit weight. \square

Lemma 13 The only $\frac{1}{2}$ -arcs that could exist in a triangulation of unit arcs are tower arcs. Note that this lemma is a corollary of 7.

Proof. Let r be a $\frac{1}{2}$ -arc. Then by the definition of a k -arc (27), r passes through a triangle at the start of the arc and only squares along the rest of the arc. Notice that r divides the polygon into two sub-polygons, an n_1 -gon and an n_2 -gon.

If the squares form a straight line, then r is a tower arc. Otherwise, the squares contain at least one turn. We will prove by contradiction that if r is not a tower arc, then it cannot be part of any unitary triangulation. If r is in a unitary triangulation, then there exist unitary dissections of both the n_1 -gon and the n_2 -gon. Without loss of generality, consider the n_1 -gon. We need $n_1 - 3$ arcs to triangulate the n_1 -gon. Since the arcs among squares are non-unitary by Proposition 7, the only arcs that can have unit weights are the ones between the triangle and a square. There are $n_1 - 3$ such arcs. Furthermore, by Lemma 9, we know that the arc between the top vertex of the roof and the vertex of any square one turn away from the triangle is not a unit. Thus we only have $n_1 - 4$ arcs between the triangle and squares that can appear in the triangulation. But we need $n_1 - 3$ arcs to form a triangulation of the n_1 -gon. Therefore if r is not a tower arc, then r cannot exist in a unitary triangulation. \square

Definition A path is a sequence of squares and triangles from dissection, where two adjacent shapes share an edge.

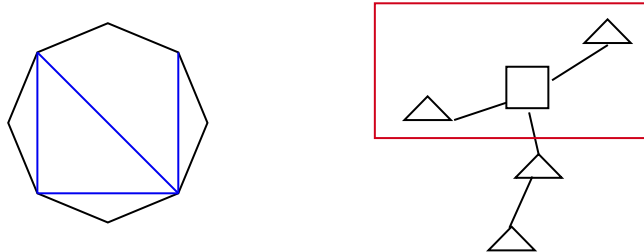

Any dissection of a polygon can be seen as a tree graph with each vertex being a triangle or a square. Thus a path in the dissection is equivalent to a path on the tree graph from dissection.

Lemma 14 Let $k > 1$ be the maximum number of triangles that can be traversed in a given path. Consider the triangulations that use only tower arcs and k -arcs. For any such triangulation of any gluings of two towers each with at least one square, at least one k -arc has a non-unit weight.

Proof. There are four ways to glue two towers each with at least one square together with k strictly greater than 1. We will show that at least one k -arc in each triangulation that only uses tower arcs and k -arcs of a gluing of two towers each with at least one square has a non-unit weight.

1. Consider the first way to glue together two towers. Then $k = \frac{3}{2}$ in this case. There are two ways to triangulate the gluing of two towers using only $\frac{3}{2}$ -arcs and tower arcs. Notice that both triangulations use the arc ab . We will show that ab has a non-unit weight.

Let the left tower have n squares and the right tower have m squares. Let w_{ab} denote the weight of the arc ab .

Then applying the Ptolemy relation to the quadrilateral $abcd$ gives

$$w_{ab} = m(1 + \sqrt{2})^n + (1 + \sqrt{2})^{n-1} \cdot (1 + \sqrt{2})^m$$

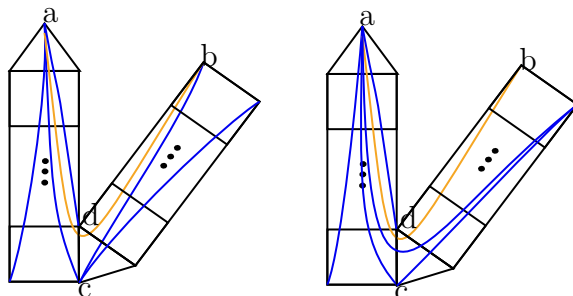

The first way of gluing two towers together.

There are three cases for the exponents of $(1 + \sqrt{2})$ in the above expression of w_{ab} .

(a) $n < n - 1 + m$

Note that since this equality is strict, $m \neq 0$. Then we have

$$\begin{aligned} w_{ab} &= (1 + \sqrt{2})^n (m + (1 + \sqrt{2})^{n-1+m-n}) \\ \Rightarrow N(w_{ab}) &= N((1 + \sqrt{2})^n) N(m + (1 + \sqrt{2})^{n-1+m-n}) \\ \Rightarrow N(w_{ab}) &= 1 \cdot N(m + (1 + \sqrt{2})^{n-1+m-n}) \\ \Rightarrow N(w_{ab}) &> 1 \end{aligned}$$

(b) $n = n - 1 + m$

Again, note that $m \neq 0$ since $m = 0$ only when $n = 1$, and we have that $n > 1$ by definition of our red arc.

We have that

$$\begin{aligned} w_{ab} &= (1 + m)((1 + \sqrt{2})^n) \\ \Rightarrow N(w_{ab}) &= N(1 + m) N((1 + \sqrt{2})^n) \\ \Rightarrow N(w_{ab}) &= N(1 + m) \cdot 1 \\ \Rightarrow N(w_{ab}) &= (m + 1)^2 > 1 \end{aligned}$$

(c) $n > n - 1 + m$

By the same reasoning as in the second case, $m \neq 0$. We have that

$$\begin{aligned} w_{ab} &= (1 + \sqrt{2})^{n-1+m} (1 + m(1 + \sqrt{2})^{n-n-1-m}) \\ \Rightarrow N(w_{ab}) &= N((1 + \sqrt{2})^{n-1+m}) N(1 + m(1 + \sqrt{2})^{n-n-1-m}) \\ \Rightarrow N(w_{ab}) &= 1 \cdot N(m + (1 + \sqrt{2})^{n-1+m-n}) \\ \Rightarrow N(w_{ab}) &> 1 \end{aligned}$$

Therefore, we have that $N(w_{ab}) > 1$, so w_{ab} cannot be a unit in $\mathbb{Z}[\sqrt{2}]$.

2. We move on to the second gluing. It is straightforward to see that $k = 2$ in this case. Again there are two ways to triangulate this gluing two towers using only 2-arcs and tower arcs, and both triangulations use the arc ab . We will show that the weight of ab is not a unit.

Let the left tower have n squares and the right tower have m squares. Let w_{ab} be the weight of the red arc. Then

$$w_{ab} = n(1 + \sqrt{2})^m + m(1 + \sqrt{2})^n.$$

By the same method as above, we get $N(w_{ab}) > 1$ for all $m, n > 0$. Therefore, w_{ab} is not a unit.

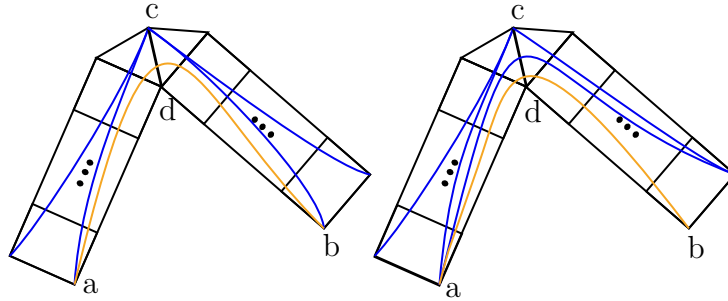

The second way of gluing two towers together

3. By Lemma 12, w_{ab} is not a unit.

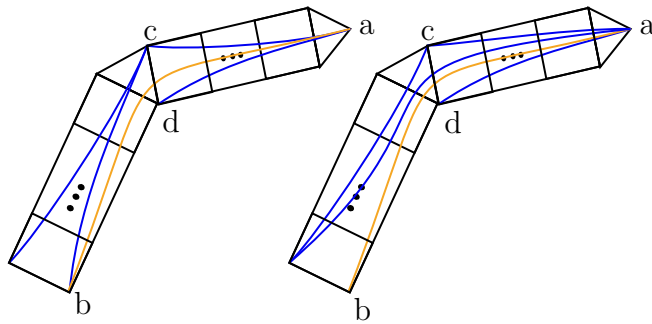

The third way of gluing two towers together

4. Next we consider the fourth way to glue together two towers. Let the left tower have n squares and the right tower have m squares. Let w_{ab} be the weight of the red arc. Then

$$w_{ab} = n(1 + \sqrt{2})^m + m(1 + \sqrt{2})^n.$$

By the same method as above, we get $N(w_{ab}) > 1$ for all $m, n > 0$.

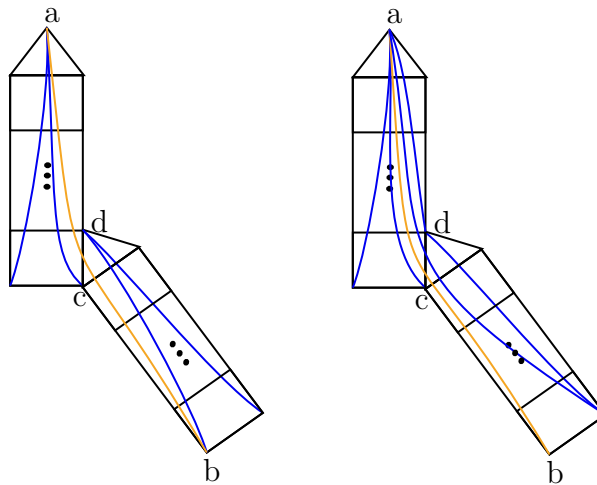

The fourth way of gluing two towers together

□

Our goal is to show that only tower arcs can appear in a unitary triangulation. In other words, we want to show that none of the k -arcs with $k \geq 1$ can exist in a unitary triangulation. When $k = 1$, we can generalize Lemma 10 and Lemma 11 to show that all 1-arcs are not units. Since 1-arcs can be explicitly shown to be non-units, we move on to $k > 1$ in Theorem 7.

Theorem 7 For a dissection into a path of triangles and squares, if there exists a k -arc in a triangulation of units with k being the maximum number of triangles that an arc can cross, then there must be a $1 \leq \ell < k$ arc in such a triangulation.

Proof. First let k be the maximum number of triangles an arc could pass through in a given path. We want to show that k -arcs, tower arcs alone cannot form a unitary triangulation, which means that there must be a $1 \leq \ell < k$ arc to complete the triangulation if a unitary triangulation exists.

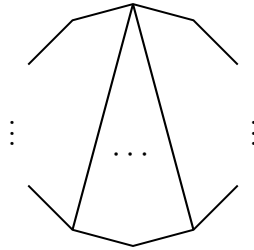

Pick an arbitrary orientation for the path such that one end of the path is considered the start and the other end the end. We don't need to consider the 0-arcs, which are the arcs from dissection, because all the arcs from dissection intersect with at least one k -arc by the maximality of the k -arc and the fact that the dissection forms a path. If a triangulation has more than one k -arc, we call the k -arc with no k -arc to its left the leftmost arc and we call the k -arc with no k -arc to its right the rightmost arc. By the construction of k -arcs, all the k -arcs pass through the same side of the first triangle because if there were a line of squares beyond the first or the last triangle, the squares only share one edge with the first or the last triangle. Since all tower arcs connect the roof vertex of the triangle in the tower and the vertices of the squares in the tower, a tower arc either crosses or is outside the sub-polygon between a left k -arc and a right k -arc. This means that the sub-polygon between the right k -arc and the left k -arc can only be triangulated by k -arcs. And the sub-polygon between the left k -arc and the left boundary of the path, as well as the sub-polygon between the right k -arc and the right boundary of the path, needs to be triangulated by tower arcs. Similarly, if a triangulation only has one k -arc, then the single k -arc divides the path into two sub-polygons that each needs to be triangulated by tower arcs.

We will consider the triangulation of the two sub-polygons outside the k -arcs. By the construction of tower arcs, no three tower arcs form a triangle. So there are only four ways to form a triangle in the two sub-poly outside the k -arcs. We could use

1. two boundary arcs and a tower arc
2. two boundary arcs and a k -arc

3. a boundary arc, a tower arc, and a k -arc
4. two tower arcs and a k -arc (use the leftmost k -arc if we are triangulating the left sub-polygon and the rightmost k -arc if we are triangulating the right sub-polygon).

There must be exactly one triangle in the triangulation that uses the leftmost or rightmost k -arc in each of the two sub-polygons. Indeed there is only one k -arc in each of the two sub-polygons next to the boundary, and any triangulation of a polygon uses all the boundary edges.

Also, since $k > 1$, each k -arc must pass through more than one triangle in the middle or two triangles at the end. Therefore, to form a triangulation in both sub-polygons, the leftmost k -arc and the rightmost k -arc must pass through exactly two consecutive towers. The picture below indicates an example of two ways to triangulate a gluing of two towers with only k -arcs and tower arcs.

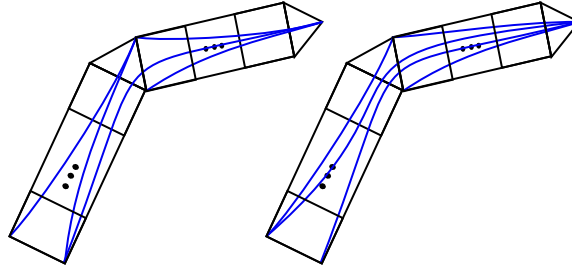

two ways to triangulate a gluing of two towers
with $k = \frac{3}{2}$ -arcs and tower arcs

Indeed, since k is maximum, any two k -arcs must pass through the same number of triangles. Assume without loss of generality, assume the left k -arc forms a triangle with two arcs that are either tower arcs or boundary arcs. We know that the left k -arc and the right k -arc must start and end in exactly two consecutive towers with at least one of the two triangle in the middle of the arc. Indeed, if there were more than two towers, then the rightmost arc will not be able to form a triangle with any tower arcs or boundary arcs since there will be more than two such arcs on the rightmost side

There are four ways to glue together two towers (each has at least one square) with at least one of the two triangle in the middle of the arc. The k -arc placed in the two towers must traverse both triangles, and at least one of the two sub-polygons divided by the k -arc must be triangulated using just the k -arc and tower arcs. By Lemma 14, we know that there is at least one such k -arc that is not a unit in all the gluings of two towers with at least one triangle in the middle. So we cannot use these k -arcs for a unitary triangulation.

Thus if k is the maximum number of triangles an arc could pass through in a given path, k -arcs and tower arcs alone cannot form a unitary triangulation of the path. Therefore there must be a $1 \leq l < k$ arc in a triangulation that involves a k -arc.

Conjecture For a dissection into a path of triangles and squares, if there exists a k -arc in a triangulation of units for any $k > 1$, then there must be a $1 \leq l < k$ arc in such a triangulation.

Now consider the ℓ -arc with $1 \leq \ell < k$. By the assumption, the ℓ -arc and the k -arc are both part of a unitary triangulation. Thus both sub-polygons cut out by the ℓ arc can be triangulated with unit arcs. We want to show that Theorem 7 holds for ℓ , which means the existence of ℓ in the triangulation implied the existence of some ℓ' -arc with $1 \leq \ell' < \ell$ such a triangulation. Since the k -arc with maximum value k passes through all the triangles and since the k -arc and the ℓ -arc don't intersect, it must be the case that the ℓ -arc stays in one of the two sub-polygons cut out by the k -arc and the boundary of the path (illustrated in the first picture below). This implies that there is no k' -arc with $k' > k$ in the sub-polygon cut out by the ℓ -arc and the boundary of the path. We call this sub-polygon **the ℓ -arc bubble**.

By the same reasoning as in the k is maximum case, if the ℓ -arc closest to the boundary (either a left ℓ -arc or a right ℓ -arc) does not form a triangle with two boundary edges, or a boundary edge and a tower arc, or two tower arcs in the ℓ -arc bubble, then the ℓ -arc bubble cannot be triangulated with just ℓ -arcs and tower arcs. This means that there must be some ℓ' -arc with $1 \leq \ell' < \ell$ in the triangulation, so Theorem 7 holds for ℓ . Otherwise, the ℓ -arc bubble can indeed be triangulated by ℓ -arcs and tower arcs. This means that if the ℓ -arc bubble falls into the following edge cases, we must use some other ways to show that the triangulation is not unitary, which implies that the k -arc cannot exist in a unitary triangulation.

One alternative way is to show that the ℓ -arc is not a unit. Another alternative way is to show that the complement of the ℓ -arc bubble in the path cannot be triangulated with unit arcs. We will show that the first alternate way of showing the ℓ arc is not a unit is not viable because it is sometimes a unit.

Edge case 1:

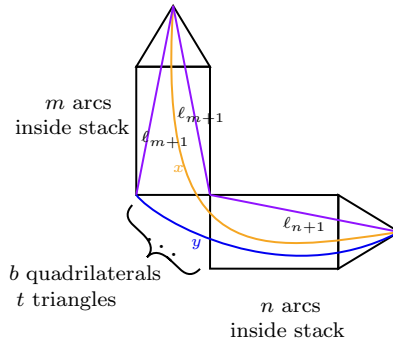

Claim: Let x denote the weight of the arc between the two towers' triangles going around the corner. Suppose that the corner vertex has b boxes and t triangles. Then $x = \ell_m \ell_n (2 + t + b\sqrt{2})$.

Proof: We first show by induction that if a vertex has b boxes and t triangles incident at it, then the 1-diagonal skipping that vertex has weight $t + b\sqrt{2}$. We have the base cases $b = 0, t = 1$ where the arc has weight 1 and $b = 1, t = 0$ where the arc has weight $\sqrt{2}$ by inspection. Suppose that we have a configuration with b boxes and t triangles.

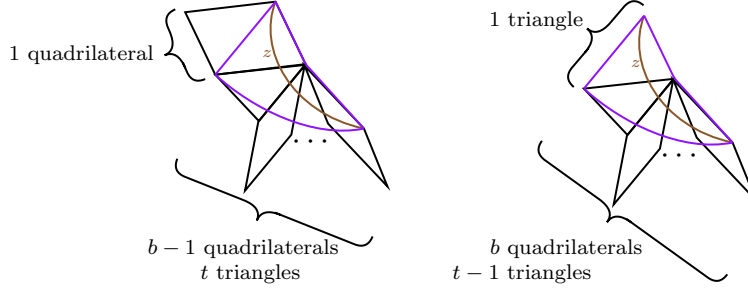

Looking at the topmost edge, it could either belong to a box (pictured left) or to a triangle (pictured right). In the case where it belongs to a box, we separate the topmost box from the rest of the configuration. Consider the purple quadrilateral (on the left) and note that one of its edges is a 1-diagonal skipping over $b - 1$ boxes and t triangles. Applying induction, this arc has weight $t + (b - 1)\sqrt{2}$. Then overall using the Ptolemy relation we have $z = 1 \cdot (t + (b - 1)\sqrt{2}) + \sqrt{2} \cdot 1 = t + b\sqrt{2}$. Similarly in the case where the topmost edge belongs to a triangle, we separate the topmost triangle from the rest of the configuration. Consider the purple quadrilateral (on the right) and note that one of its edges is a 1-diagonal skipping over b boxes and $t - 1$ triangles. Applying induction, this arc has weight $t - 1 + b\sqrt{2}$. Then overall using the Ptolemy relation we have $z = 1 \cdot 1 + 1 \cdot (t - 1 + b\sqrt{2}) = t + b\sqrt{2}$.

We then compute the weight of the arc y . In the picture below, z denotes the 1-diagonal of the corner vertex, whose weight we have just found depending on b and t .

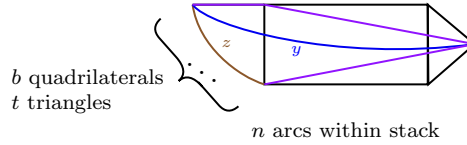

Using the pictured auxiliary arcs, we have the Ptolemy relation $y = \ell_n(z + 1)$. Finally using the quadrilateral whose edges are the two longest tower arcs in the tower of height m , the longest tower arc in the tower of height n and the arc y , we obtain

$$\begin{aligned}
 x &= \ell_m(\ell_n + y) \\
 &= \ell_m(\ell_n + \ell_n(z + 1)) \\
 &= \ell_m \ell_n(1 + t + b\sqrt{2} + 1) \\
 &= \ell_m \ell_n(2 + t + b\sqrt{2}).
 \end{aligned}$$

Note that the weight of x need not be non-unitary. There is a family of ordered pairs (b, t) for which x is a unit. For example $(2, 1), (5, 5), (12, 15), (29, 39)$ are the first four such ordered pairs.

Let x_1 and x_2 denote the weights of the arcs pictured below. Suppose that the corner vertex has b boxes and t triangles. Then $x_1 = \ell_n(d_m(1 + t + b\sqrt{2}) + s_m)$ and $x_2 = \ell_n(d_m + s_m(1 + t + b\sqrt{2}))$.

Edge case 2:

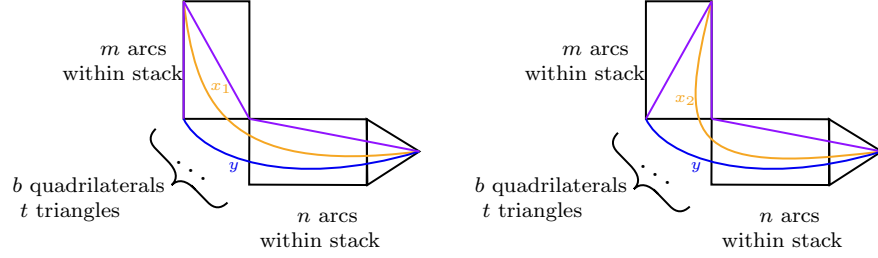

We situate x_1 as a diagonal of the quadrilateral drawn with purple and blue arcs. Note that the bottom blue arc is exactly the quantity called y from the previous Fact (which depends on the number of boxes b and triangles t). Then using the Ptolemy relation, we obtain $x_1 = s_m \ell_n + d_m y = \ell_n (s_m + d_m (1 + t + b\sqrt{2}))$. Similarly we use the expression for y in another Ptolemy relation to get $x_2 = \ell_n (d_m + s_m (1 + t + b\sqrt{2}))$.

Note that the weights x_1 and x_2 again need not be non-unitary. For example with the length of the stacks being $m = n = 1$, if $b = 24, t = 34$ we have $(d_m + s_m)(1 + t + b\sqrt{2}) = 3 + 2\sqrt{2}(1 + 34 + 24\sqrt{2}) = 99 + 70\sqrt{2}$ being a unit, and thus the entire product in the expression for x_1 being a unit.

Edge case 3:

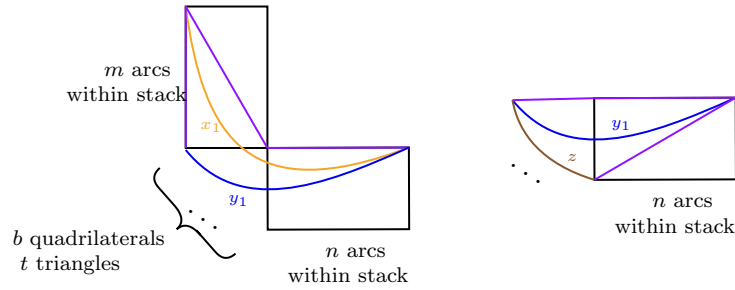

We situate x_1 as a diagonal of the quadrilateral drawn with purple and blue arcs. We first calculate the weight y_1 of the auxiliary arc on the right side picture. Using a Ptolemy relation and reusing the expression for z calculated previously, we have $y_1 = d_n + s_n z$. Then using a Ptolemy relation in the main picture on the left side, we have $x_1 = d_m y_1 + s_m s_n = d_m (d_n + s_n (t + b\sqrt{2})) + s_m s_n$.

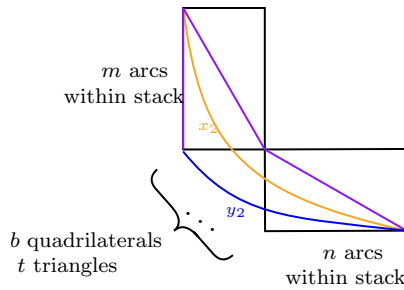

An entirely analogous process gives $y_2 = d_n z + s_n$ in the picture above and $x_2 = s_m d_n + d_m y_2 = s_m d_n + d_m (d_n (t + b\sqrt{2}) + s_n)$.

Note that the weights x_1 and x_2 need not be unitary. For example with the length of the stacks being $m = n = 1$, if $b = 0, t = 2$ we have $x_1 = 17 + 12\sqrt{2}$ being a unit. In summary, if (b, t) are specific pairs of numbers, the ℓ -arcs themselves (despite leaving a tower) turn out to be unitary.

Therefore, when the ℓ -arc bubble can be triangulated by tower arcs and ℓ -arcs and when the ℓ -arc is a unit, we need to look at the complement of the ℓ -arc bubble to show that there is no unitary triangulation involving the k -arc.

□

3.5.6 Proof of the Main Conjecture for A Special Case

Definition A **basic triangle** is a triangle that has exactly two sides being boundary arcs of a polygon. Note that the boundary arcs of such a triangle don't have to have weight 1.

For example, the triangle with vertices agi formed by the blue arcs is a basic triangle of the polygon with vertices $abcde fgi$. Noticed that the boundary arcs of the basic triangle each have weight $(1 + \sqrt{2})$.

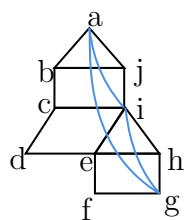

Definition A **type three** dissection is a polygon dissected into squares and triangles such that each vertex belongs to no more than three subpolygons.

Lemma 15 Suppose a triangulation arises from a type three dissection. An arc that forms a triangle with a tower arc and a boundary arc of a sub-polygon outside the tower does not have a unit weight.

Neither does an arc that forms a triangle with two adjacent tower arcs from two different towers.

Example (the blue arcs don't have unit weights):

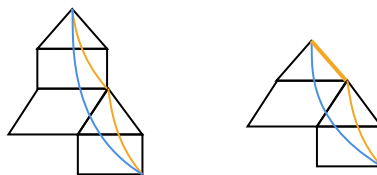

Proof. There are 36 such cases as indicated in the picture below: 18 of them are arcs that connect tower arcs with boundary arcs of squares and triangles, 18 of them are arcs connecting two tower arcs. The boundary arcs in cases 1 to 9 consist of a tower arc and an arc from a triangle. The boundary arcs in cases 10 to 18 consist of a tower arc and an arc from a rectangle. The boundary arcs in cases 19 to 36 consist of two tower arcs.

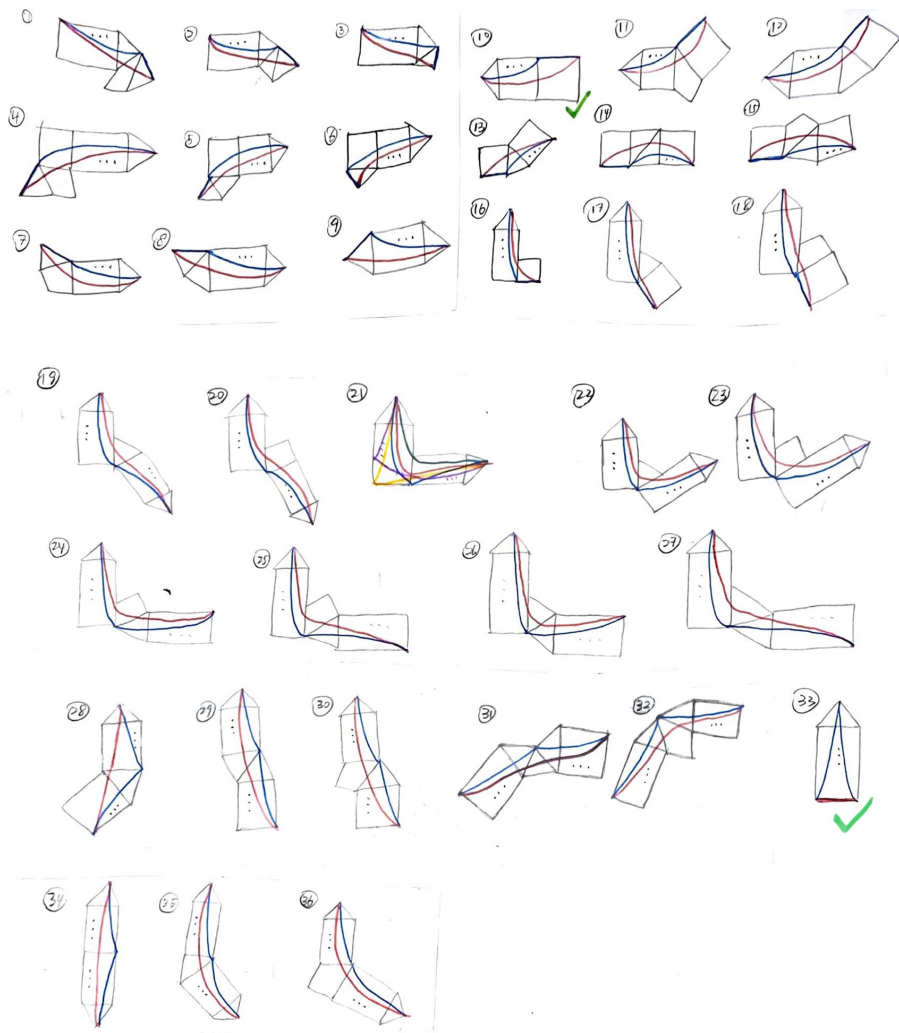

In each case, we can identify a quadrilateral including the arc in question and a puzzle-piece-arc. All other arcs in the quadrilateral are unit arcs. Apply the ptolemy relation to the quadrilateral. Then we can find the weight of the arc in question. One can readily check that the arcs in all except the ones in the same tower have non-unit weights.

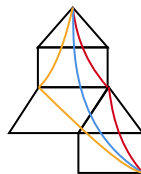

As an example, we will show that the non-boundary arc of the basic triangle in case 30 has a non-unit weight. This arc corresponds to the blue arc in the picture below. Let the top tower be an m -tower and the bottom tower be an n -tower. And let the weight of the blue arc be x .

Then apply the ptolemy relation to the quadrilateral with colored boundary arcs, and we get

$$\begin{aligned}
x &= (1 + \sqrt{2})^m (s_1 d_n + l_{n+1} d_1) + (1 + \sqrt{2})^{n+m} \\
&= (1 + \sqrt{2})^m (s_1 d_n + l_{n+1} d_1 + (1 + \sqrt{2})^n) \\
&= (1 + \sqrt{2})^m (2\sqrt{2}d_n + 3(1 + \sqrt{2})^{n+1} + (1 + \sqrt{2})^n) \\
&= (1 + \sqrt{2})^m (2\sqrt{2}d_n + (4 + 3\sqrt{2})(1 + \sqrt{2})^n)
\end{aligned}$$

Indeed, one of the orange arcs has weight $s_1 d_n + l_{n+1} d_1$ by Lemma 11. However, $(2\sqrt{2}d_n + (4 + 3\sqrt{2})(1 + \sqrt{2})^n)$ is not a unit because to make it a unit, we need to increase $(4 + 3\sqrt{2})(1 + \sqrt{2})^n$ by some $(a + b\sqrt{2})(1 + \sqrt{2})^n$ with $a, b > 0$. Notice that $(a + b\sqrt{2})(1 + \sqrt{2})^n$ has non-zero integer and $\sqrt{2}$ parts, but $2\sqrt{2}d_n$ is either an integer or a multiple of $\sqrt{2}$, so the sum of $2\sqrt{2}d_n$ and $(a + b\sqrt{2})(1 + \sqrt{2})^n$ is not a unit. Therefore, x is the product of a unit and a non-unit, which means that it is not a unit. □

Lemma 16 In a triangulation of any polygon, there is at least one basic triangle.

Proof. Let P be an n -gon. Then it is known that any triangulation of P uses $n - 3$ arcs. Consider any triangulation of P . Then an arc inside P can belong to at most 2 triangles in the triangulation. Thus we have at most $(n - 3) \cdot 2$ sides of triangles inside P . A boundary arc of P belongs to exactly one triangle in the triangulation. Thus, in total, we have at most $(n - 3) \cdot 2 + n = 3n - 6$ sides of triangles. We will proceed with a proof by contradiction. Assume every triangle in the polygon has at most 1 of its sides being the boundary arc. Then there are at least n triangles in the triangulation. This implies that we have at least $3n$ sides of triangles. However, $3n > 3n - 6$, so there is at least one triangle in the triangulation that has sides being two boundary arcs. □

Lemma 17 There are nine types of basic triangles with weight-1 boundary arcs that can appear in the triangulation of a type-three dissection.

In particular, unless the non-boundary arc of the basic triangle with weight-1 boundary arcs is a tower arc, the arc does not have a unit weight.

Proof. By the definition of a basic triangle, the two sides of the triangle that are boundary arcs are either the boundary of a triangle or the boundary of a square. So there are three possibilities for the boundary arcs that are the two sides of the basic triangle: 1. a boundary arc from a triangle plus a boundary arc from a square; 2. both boundary arcs coming from triangles; 3. both boundary arcs coming from squares. Furthermore, since we allow each vertex to belong to at most three sub-polygons, it is possible that there is an extra triangle or square connected to the vertex between the two boundary arcs that are two sides of the basic triangle. This gives us three possibilities for each possibility listed above: there could be a square, a triangle, or no sub-polygon connected to the vertex between the two sides of the basic triangle. Thus, in total, there are 9 distinct basic triangles that can appear in the triangulation of a polygon dissected into squares and triangles such that no vertex belongs to more than three sub-polygons. They are the illustrated as follows:

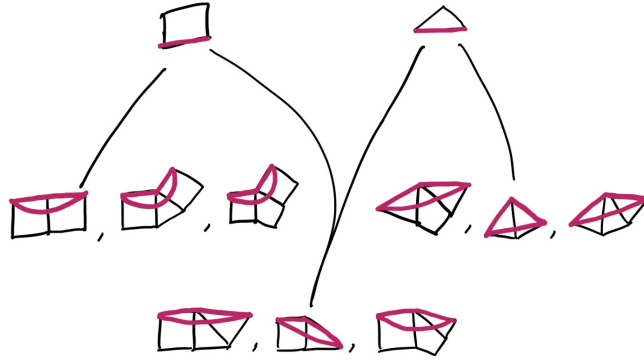

One can readily check that if a non-boundary arc in one of these basic triangles is not a tower arc, then the non-boundary arc does not have unit weights using the Sage function we wrote or the Lemmas from the previous parts of the report. \square

Theorem 8 A type-three dissection is unitary if and only if it is a gluing of towers.

Proof. The backward direction of the statement is straightforward. We will show the forward direction.

Consider a polygon P_0 dissected into squares and triangles such that each vertex belongs to no more than three sub-polygons. Call the gluing of sub-polygons from dissection D_0 . Thus D_0 is a type-three dissection. By Lemma 16, any triangulation of P_0 must have at least one basic triangle. In order to have a triangulation consisting of unit arcs. By Lemma 17, there must be at least one basic triangle in D_0 such that its non-boundary arc is a tower arc. Otherwise, this dissection does not have a unitary triangulation, as every basic triangle would have an arc with a non-unit weight. Then consider the polygon P_1 formed by the tower arc coming from the basic triangle and the rest of the boundary arcs of P_0 . Notice that any triangulation of P_1 is induced by the corresponding triangulation of P_0 . Again, by Lemma 16, we know that any triangulation of P_1 must have at least one basic triangle. By 15, we know that a tower arc only forms a unitary triangle with arcs in the same tower. For example, the third side of the triangle formed by two tower arcs in the same tower is an arc from dissection, so it has weight 1. In addition, by Lemma 17, we know that the non-boundary arc of a basic triangle with two weight-one boundary arcs has a unit weight if and only if the non-boundary arc is a tower arc. So if the dissection of P_0 is unitary, there must be at least one basic triangle whose non-boundary arc is either a tower arc or an arc from dissection that lies in the same tower as the two boundary arcs.

Repeat this process: each time, we form a unitary sub-triangulation of the sub-polygon P_i contained in P_{i-1} . The process terminates when one of the two following cases happens: 1. a triangulation with unit-weight arcs is formed. 2. the sub-polygon is not triangulated, but we cannot find a basic triangle that has a unit-weight non-boundary arc anymore. Therefore, if D_0 is unitary, every unitary triangulation of D_0 contains only tower arcs and arcs from dissection. But if D_0 is not a gluing of towers, we would not have enough tower arcs or arcs from dissection to triangulate the part of D_0 that does not belong to a tower. Therefore, if D_0 is not a gluing of towers, it is not unitary. \square

Definition A point incident to more than three subpolygons is called a **sink**.

The difficulty of the general case is that if the vertex connecting the two boundary edges of a basic triangle is a sink, then the non-boundary edge of the basic triangle could have a unit weight despite it not being a tower arc.

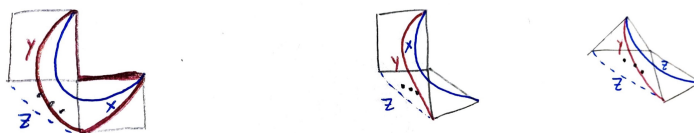

There are three types of basic triangles that have a sink connecting two weight-one boundary edges. Consider the first of the three types, where the two boundary edges both belong to squares. By the proof for one of the edge cases in the report, the arc z has weight $t + b\sqrt{2}$ with t and b indicating the number of triangles and squares incident to the sink. Then apply the ptolemy relation to the quadrilateral containing both z and y , and we get the weight of y is $t + (b + 1)\sqrt{2}$. Then apply the ptolemy relation to the quadrilateral containing both x and y (marked in red), and we get the weight of x is $(2 + b)\sqrt{2} + t$. Thus for certain pairs of (t, b) , x is a unit. For example, when (t, b) equals $(0, 3)$, $(3, 7)$, $(10, 17)$, x is a unit.

Similarly, we can get that for the second type of basic triangles with a sink, the weight of x is $(b + 1)\sqrt{2} + (t + 1)$. Thus for certain values of (t, b) , the weight of x is a unit. For example, (t, b) could be equal to $(2, 1)$, $(6, 4)$, $(16, 11)$.

Finally, for the third type of basic triangles with a sink, the weight of x is $(t + 2) + b\sqrt{2}$. Thus for certain values of (t, b) , the weight of x is a unit. For example, (t, b) could be equal to $(1, 2)$, $(5, 5)$, $(15, 12)$.

Furthermore, even if a basic triangle has a tower arc as one of its boundary edges, it is still possible for the non-boundary edge of the triangle have a non-unit weight. Below is an example containing such a basic triangle. Let the two towers in the example have m and n squares respectively. Then the non-boundary edge of the basic triangle consisting of red and blue arcs has the weight $\ell_m \ell_n (2 + t + b\sqrt{2})$. Thus for certain pairs of (t, b) such as $(1, 2)$, $(5, 5)$, $(15, 12)$, the weight of the non-boundary arc is a unit. Therefore, it is possible for all three sides of the basic triangle to have unit weight when we allow the existence of a sink in a dissection.

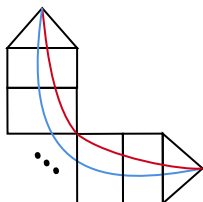

Having more than three subpolygons incident to a vertex increases the complexity of the dissection, allowing the non-boundary arc of more basic triangles to have a unit weight. Therefore, the strategy used to prove the special case of type-three dissections does not apply to the general case.

3.6 Friezes in $\mathbb{Z}[\sqrt{3}]$

Proposition 9 For an n -gon with $n \leq 9$, no dissection into triangles and at least one hexagon gives a unitary frieze.

Proof. One can check all the cases using Sage code 5.2 listed in the Appendix. □

Definition A **tower** in $\mathbb{Z}[\sqrt{3}]$ is a dissection of a $4n + 3$ -gon whose simplified diagram consists of a stack of height $n \geq 0$ with a triangle on top. When $n = 0$, the tower is just a triangle.

Definition A **tower arc** in $\mathbb{Z}[\sqrt{3}]$ is a $2n$ -diagonal going from the top vertex of the roof to a vertex in the n th hexagon counting from the roof.

We denote the weight of the tower arc in $\mathbb{Z}[\sqrt{3}]$ that crosses k arcs from dissection as ζ_k .

Lemma 18 In a regular hexagon, every 1-diagonal has weight $\sqrt{3}$ and every 2-diagonal has weight 2.

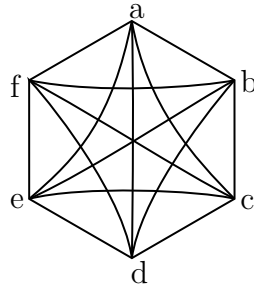

Proof. Let x be the weight of a 1-diagonal and y be the weight of a 2-diagonal. Apply the Ptolemy relation to the quadrilateral $abcf$, and we get the equation $x^2 = y + 1$. Next apply the Ptolemy relation to the quadrilateral $bcdf$, and we get another equation $xy = 2x$. Solve the two equations for x and y , and we have $x = \sqrt{3}$ and $y = 2$. Therefore, every 1-diagonal has weight $\sqrt{3}$ and every 2-diagonal has weight 2. □

Theorem 9 Every tower arc in $\mathbb{Z}[\sqrt{3}]$ is a unit. In particular, $\zeta_n = (2 + \sqrt{3})^n$.

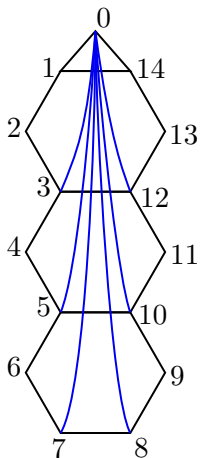

Proof. Let $w_{(i,j)}$ be the weight of the arc (i,j) . Let (i,j,k,ℓ) be the quadrilateral with its vertices labeled by the numbers i,j,k,ℓ . By Lemma 18, we know that $w_{(1,13)} = w_{(1,3)} = w_{(3,13)} = \sqrt{3}$. We will prove the theorem by induction. Consider the base case, where we will show that $\zeta_1 = 2 + \sqrt{3}$. Apply the Ptolemy relation to the quadrilateral $(0, 14, 13, 1)$, and we get $w_{(0,13)} = \sqrt{3} + 1$. Then apply the Ptolemy relation to the quadrilateral $(0, 13, 3, 1)$, and we get $w_{(0,3)} = 2 + \sqrt{3}$. Finally apply the Ptolemy relation to the quadrilateral $(0, 13, 12, 3)$, and we get $w_{(0,12)} = 2 + \sqrt{3}$. So the base case is done. Next consider the induction step. Let $(0, a)$ and $(0, b)$ be the two tower arcs in $\mathbb{Z}[\sqrt{3}]$ that cross n arcs from dissection, and let $(0, c)$ and $(0, d)$ be the two tower arcs in $\mathbb{Z}[\sqrt{3}]$ that cross $n + 1$ arcs from dissection. Assume $\zeta_n = (2 + \sqrt{3})^n$. Then $(0, a)$ and $(0, b)$ each have weight ζ_n , and we will show that $(0, c)$ and $(0, d)$ each have weight ζ_{n+1} . Notice that $(0, a)$ and $(0, b)$ form a quadrilateral with a 1-diagonal and a 2-diagonal in the $(n + 1)$ th hexagon counting from the roof. Also notice that $(0, c)$ and the n th arc from dissection are the two diagonals of the quadrilateral. Apply the Ptolemy relation to the quadrilateral, and we get $w_{(0,c)} = \zeta_n \cdot 2 + \zeta_n \cdot \sqrt{3} = (2 + \sqrt{3})\zeta_n = (2 + \sqrt{3})^{n+1}$. By the same reasoning, we have $w_{(0,d)} = (2 + \sqrt{3})^{n+1}$ as well.

The induction step could be illustrated in the following example. Assume $\zeta_2 = (2 + \sqrt{3})^2$. Then $(0, 10)$ and $(0, 5)$ form a quadrilateral with the 1-diagonal $(5, 7)$ and the 2-diagonal $(7, 10)$ in the 3rd hexagon counting from the roof. Apply the Ptolemy relation to the quadrilateral, and we get $w_{(0,7)} = \zeta_2 \cdot 2 + \zeta_2 \cdot \sqrt{3} = (2 + \sqrt{3})\zeta_2 = (2 + \sqrt{3})^3$. Similarly, we have $w_{(0,8)} = (2 + \sqrt{3})^3$ as well.

Therefore, the induction step is done, which implies that $\zeta_n = (2 + \sqrt{3})^n$ for all n . □

Conjecture In $\mathbb{Z}[\sqrt{3}]$, the only dissection of an n -gon that gives a unitary frieze is the dissection into triangles.

4 Future Directions:

Our immediate goal is to show that the conjectures for $\mathbb{Z}\sqrt{2}$ (3.5.5) and $\mathbb{Z}\sqrt{3}$ (3.6) holds in general. Then we are set up to count the number of unitary friezes from dissection in since all

the unitary dissections will be restricted to gluings of towers in the case of $\mathbb{Z}\sqrt{2}$ and to only triangles in the case of $\mathbb{Z}\sqrt{3}$. This means that the number of unitary friezes from dissection in both cases would be finite.

There are other interesting problems related to dissections of an n -gon into triangles and squares that we have not explored. For example, we would like to know how many dissections into triangles and squares there are up to rotation and reflection. Right now, we have a formula in Section 3.3 for when the vertices of the n -gon are labeled. However, if two dissections are the same up to symmetry, then they produce the friezes up to symmetry. Thus reducing the dissections by symmetry will allow us to count the number of distinct friezes produced by dissection.

Another direction to take is characterizing and determining the finiteness of the intersections of the other types of friezes. We have a few conjectures:

- Conjecture**
1. There are only finitely many $\mathbb{Z}[\sqrt{2}]_{\geq 1}$ friezes.
 2. There are only finitely many $\mathbb{Z}_{\geq 0}[\sqrt{2}]$ friezes.

If we cannot prove both or either of these, the following two corollaries may be tractable:

- Conjecture** For a given an n -gon,
1. The set $\{\text{unitary friezes}\} \cap \{\mathbb{Z}[\sqrt{2}]_{\geq 1} \text{ friezes}\}$ is finite.
 2. The set $\{\text{unitary friezes}\} \cap \{\mathbb{Z}_{\geq 0}[\sqrt{2}] \text{ friezes}\}$ is finite.

Moving beyond dissections of polygons, we could venture into dissections on disks with a single puncture, which correspond to friezes of type D , generalizing work in [2] and [7]. We can characterize the dissections of punctured disks that produce unitary friezes. How are the unitary friezes of type A relate to those of type D ?

Furthermore, when we dissect a polygon into sub-polygons p_1, p_2, \dots, p_n that are not just triangles and squares, can we classify frieze vectors over $\mathbb{Z}[\lambda_{p_i}]$, where $\lambda_{p_i} = 2\cos(\pi/p_i)$ with $i \in (1, \dots, n)$?

Acknowledgements

This project was partially supported by NSF RTG grant DMS-1148634 and NSF grant DMS-1949896. It was supervised as part of the University of Minnesota School of Mathematics Summer 2021 REU program. The authors would like to thank our mentor and TAs, Esther Banaian, Kayla Wright, and Libby Farrell, for their guidance and support, Vic Reiner for organizing this REU, and Trevor Karn for helping us with Sage.

5 Appendix

5.1 Dissections into triangles and quadrilaterals

```

def produce_dissection(n):
    if n==2:
        return ([[[]]])
    diss= []
    for k in range(1, n-1):
        a = []
        if k != 1:
            a.append((0,k))
        if k != n-2:
            a.append((k, n-1))
        subdiss_1 = produce_dissection(k+1)
        subdiss_2 = produce_dissection(n-k)
        for s_1 in subdiss_1:
            ss_1=s_1
            for s_2 in subdiss_2:
                ss_2=[(x+k, y+k) for (x,y) in s_2]
                s_3=ss_1+ss_2+a
                diss.append(s_3)
    for l in range(1, n-2):
        for m in range(l+1, n-1):
            a = []
            if l != 1:
                a.append((0,l))
            if l != m-1:
                a.append((l,m))
            if m != n-2:
                a.append((m, n-1))
            subdiss_1 = produce_dissection(l+1)
            subdiss_2 = produce_dissection(m-l+1)
            subdiss_3 = produce_dissection(n-m)
            for s_1 in subdiss_1:
                ss_1=s_1
                for s_2 in subdiss_2:
                    ss_2=[(x+l, y+l) for (x,y) in s_2]
                    for s_3 in subdiss_3:
                        ss_3=[(x+m, y+m) for (x,y) in s_3]
                        s_4=ss_1+ss_2+ss_3+a
                        diss.append(s_4)
    return diss

```

5.2 Friezes from dissection and deciding whether they are unitary

```

def frieze-maker (quiddity_row):
    quiddity_row = vector(ZZ[sqrt(2)], quiddity_row)
    n = len(quiddity_row)

    frieze_matrix = Matrix(R, n-1, n+1)

    frieze_matrix[0, :] = 1 # the first row will be all ones

    frieze_matrix[1, :-1] = quiddity_row # the second row is the quiddity_row

    # matrix is already initialized: frieze_matrix
    # third_row = sage.matrix.special.ones_matrix(R, 1, n-1, sparse=False)

    for row in range(2, n-1): #start in the third row (index two)
        for col in range(0, n-row+1): # iterate over all the columns
            frieze_matrix[row, col] = ((frieze_matrix[row-1, (col+1)]-1) / frieze_matrix[row-2, (col+1)])

    return frieze_matrix

# This helps us find all the arcs of unitary weight. It does so by checking the norm is plus or minus 1
def unitary_arc_spotter(m):
    how_tall = m.nrows()
    how_wide = m.ncols()
    unitary_arcs = []
    for row in range(1, how_tall - 1):
        y = m[row, 0].norm()
        if abs(y) == 1:
            unitary_arcs.append((0, row + 1))
    for col in range(1, how_tall):
        y = m[row, col].norm()
        if abs(y) == 1:
            unitary_arcs.append((col, row + col + 1))
    return unitary_arcs

def dissection_spotter(m):
    how_tall = m.nrows()
    how_wide = m.ncols()
    one_arcs = []
    for row in range(1, how_tall - 1):
        if m[row, 0] == 1:
            one_arcs.append((0, row + 1))
    for col in range(1, how_tall):
        for row in range(1, how_tall - col):
            if m[row, col] == 1:
                one_arcs.append((col, row + col + 1))
    return one_arcs

# Helps decide whether there exists a triangulation into units. Faster/more direct than the function called unitary-triangulation-decider-slower
import itertools
# Input list of ordered pairs of arcs that are unitary
def unitary-triangulation-decider(unitary_arcs, n):
    m = n-3
    if len(unitary_arcs) < m:
        return("Not unitary because not enough unitary arcs")
    elif len(unitary_arcs) >= m:
        candidate-triangulations = Combinations(unitary_arcs, m) # An n gon needs n-3 arcs for a triangulation. These are all the ways
        # The strategy is to give each candidate triangulation a score. They start with zero, and each time some pair of arcs crosses, it gets +1
        scores = [0]*(len(candidate-triangulations))
        for i in range(len(candidate-triangulations)):
            all_pairs_of_arcs = Combinations(candidate-triangulations[i], 2)
            for pair_of_arcs in all_pairs_of_arcs: # Check for pairwise crossings within each candidate triangulation
                if pair_of_arcs[0][0] != pair_of_arcs[1][0] and pair_of_arcs[0][1] != pair_of_arcs[1][1] and pair_of_arcs[0][1] != pair_of_arcs[1][0] and pair_of_arcs[1][0] != pair_of_arcs[0][0]:
                    scores[i] = scores[i] + 1
            elif pair_of_arcs[0][0] != pair_of_arcs[1][0] and pair_of_arcs[0][1] != pair_of_arcs[1][1] and pair_of_arcs[1][0] != pair_of_arcs[0][0] and pair_of_arcs[1][1] != pair_of_arcs[0][1]:

```

References

- [1] Esther Banaian and Jiuqi Chen. *Periodic Infinite Frieze Patterns of Type $\Lambda_{p_1, \dots, p_n}$ and Dissections on Annuli*. 2021. URL: [arXiv:2106.06679](https://arxiv.org/abs/2106.06679).
- [2] Karin Baur and Robert J Marsh. “Frieze patterns for punctured discs”. In: *Journal of Algebraic Combinatorics* 30.3 (2009), pp. 349–379.
- [3] J.H. Conway and H.S.M Coxeter. “Triangulated polygons and frieze patterns”. In: *The Mathematical Gazette* 400 (1973), pp. 87–94.
- [4] H.S.M. Coxeter. “Frieze Patterns”. In: *Acta. Arith.* 18 (1971), pp. 297–310.
- [5] Sergey Fomin, Michael Shapiro, and Dylan Thurston. “Cluster algebras and triangulated surfaces. Part I: Cluster complexes”. In: *Acta Mathematica* 201.1 (2008), pp. 83–146.
- [6] Sergey Fomin and Andrei Zelevinsky. “Cluster algebras I: foundations”. In: *Journal of the American Mathematical Society* 15.2 (2002), pp. 497–529.
- [7] Bruce Fontaine and Pierre-Guy Plamondon. “Counting friezes in type D_n ”. In: *Journal of Algebraic Combinatorics* 44 (2016), pp. 433–445.
- [8] Emily Gunawan and Ralf Schiffler. “Frieze Vectors and Unitary Friezes”. In: *Journal of Combinatorics* 11.4 (2020), pp. 681–703.
- [9] Thorsten Holm and Peter Jørgensen. “A p -angulated generalisation of Conway and Coxeter’s theorem on frieze patterns”. In: *International Mathematics Research Notices* (2017).
- [10] Sophie Morier-Genoud. “Coxeter’s frieze patterns at the crossroads of algebra, geometry and combinatorics”. In: *Bulletin of the London Mathematical Society* 47.6 (2015), pp. 895–938.
- [11] Lauren Williams. “Cluster algebras: an introduction”. In: *Bulletin of the American Mathematical Society* 51.1 (2014), pp. 1–26.